

CLOSET & HOME SOLUTIONS  
2022



# CONTENTS

<b>Loox LED Illumination/Sliding Solutions</b>	<b>3-6</b>
<b>Service+ Custom Products</b>	<b>7-16</b>
<b>Wardrobe Fittings</b>	<b>17-48</b>
<b>Wardrobe Accessories</b>	<b>49-70</b>
<b>Wall Beds</b>	<b>71-76</b>
<b>Garage Organization</b>	<b>77-103</b>
<b>Laundry, Pantry, Wine and More</b>	<b>104-113</b>
<b>Home Office</b>	<b>114-133</b>
<b>Shelving</b>	<b>134-138</b>
<b>Decorative Hardware</b>	<b>139-167</b>



# IDEALLY SUITED

At Häfele, closets and other storage and organization projects – garages, laundry rooms, pantries, mudrooms, entertainment centers, craft areas, home offices and beyond – thrive on one thing: coordination. That means continuity of design: elements which match and fit a certain level of quality and aesthetics. Also, a coordination of vision: giving you the pieces you need – regardless of whether users see them or not – to realize whatever it is you've designed, conceived or dreamt.

# LOOX LED ILLUMINATION



A closet project, whether a simple reach-in or a luxurious walk-in, is not complete without well-integrated illumination. It adds a crucial functional design element, one which transforms the look of your space.

HÄFELE'S LOOX5 LED LIGHTING is the industry's premier option for closet and organizational illumination.

THE COUTURE CLOSET  
Photographer: Dan Plassick

# FIXTURES

UP LIGHTING. STRIP LIGHTING. PUCK LIGHTS. ILLUMINATED SHELVES. LIGHTED WARDROBE TUBES.  
Wherever you'd like to cast light within the closet space, Häfele's Loox5 LED lighting provides easy and adaptable solutions.

LIGHTED WARDROBE TUBES



STRIP LIGHTING

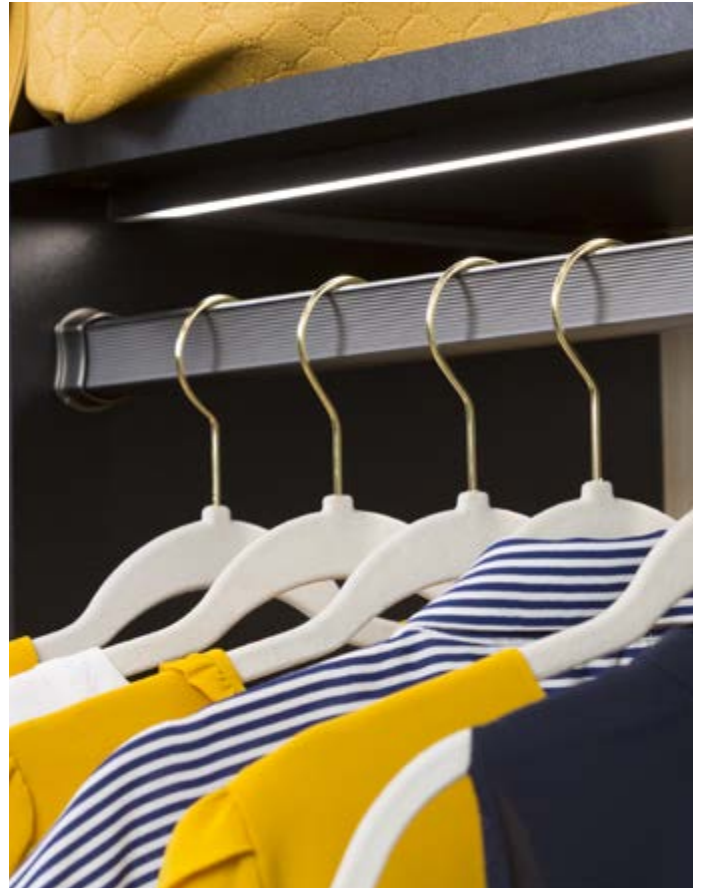

PUCK LIGHTS



ILLUMINATED SHELVES



# SWITCHING

Some prefer to flip a standard wall switch. Others might prefer lights which turn on whenever they enter the space or open a door. Then there are also the users who prefer to create pre-set scenes. Whatever your switching preference, Häfele's Loox5 LED lighting can provide the solution – our broad range of switching options lead the industry.



# EASE OF INSTALLATION

All you need is a receptacle. Häfele's Loox5 LED lighting is most commonly installed as a "plug and play" system with standard electrical outlets – normally installed above storage space, allowing for easy wire management and bringing power to every part of your closet and storage solutions.

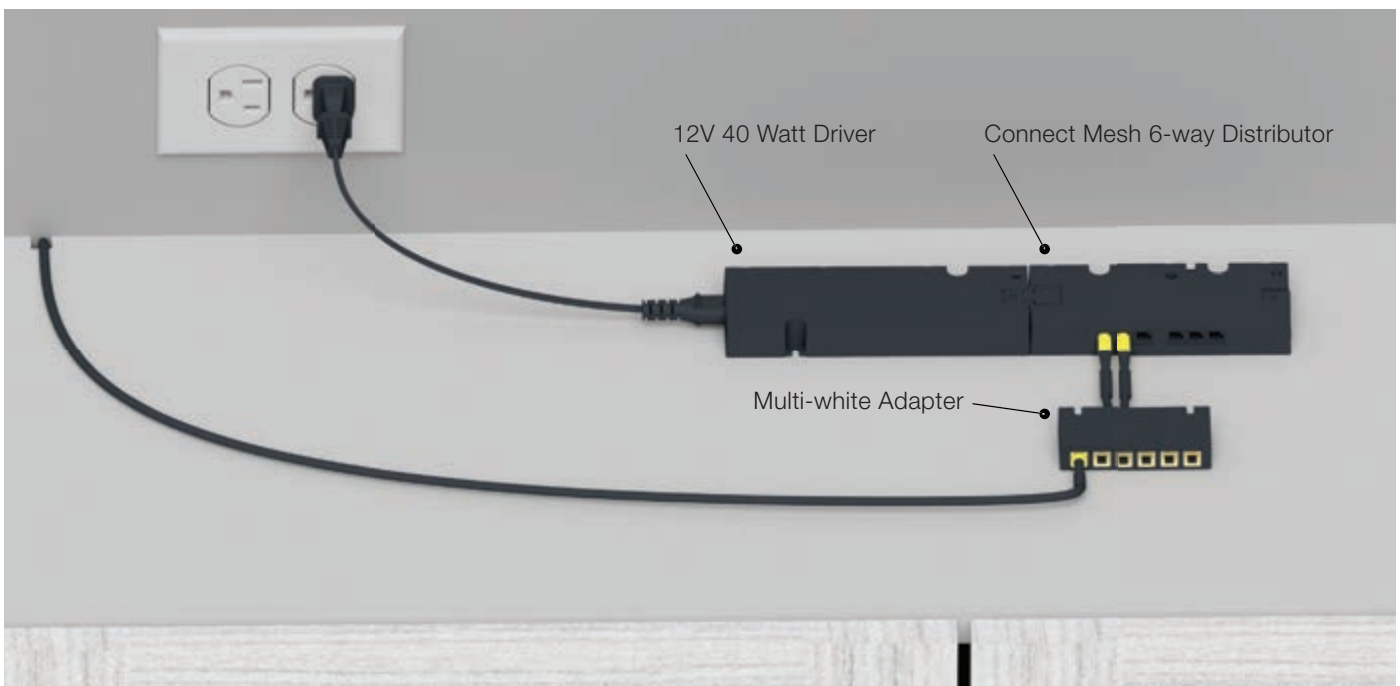

# WE'RE HERE TO HELP

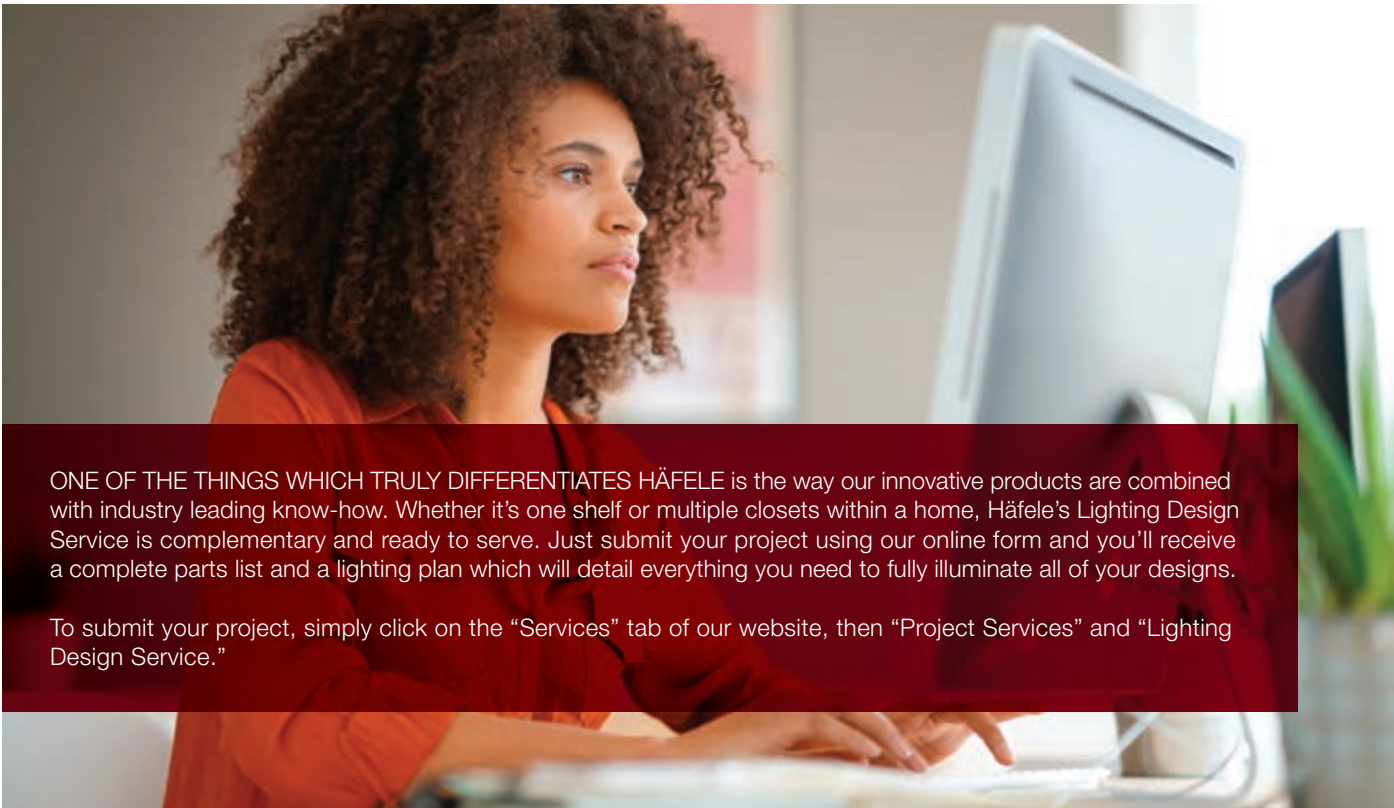

ONE OF THE THINGS WHICH TRULY DIFFERENTIATES HÄFELE is the way our innovative products are combined with industry leading know-how. Whether it's one shelf or multiple closets within a home, Häfele's Lighting Design Service is complementary and ready to serve. Just submit your project using our online form and you'll receive a complete parts list and a lighting plan which will detail everything you need to fully illuminate all of your designs.

To submit your project, simply click on the "Services" tab of our website, then "Project Services" and "Lighting Design Service."

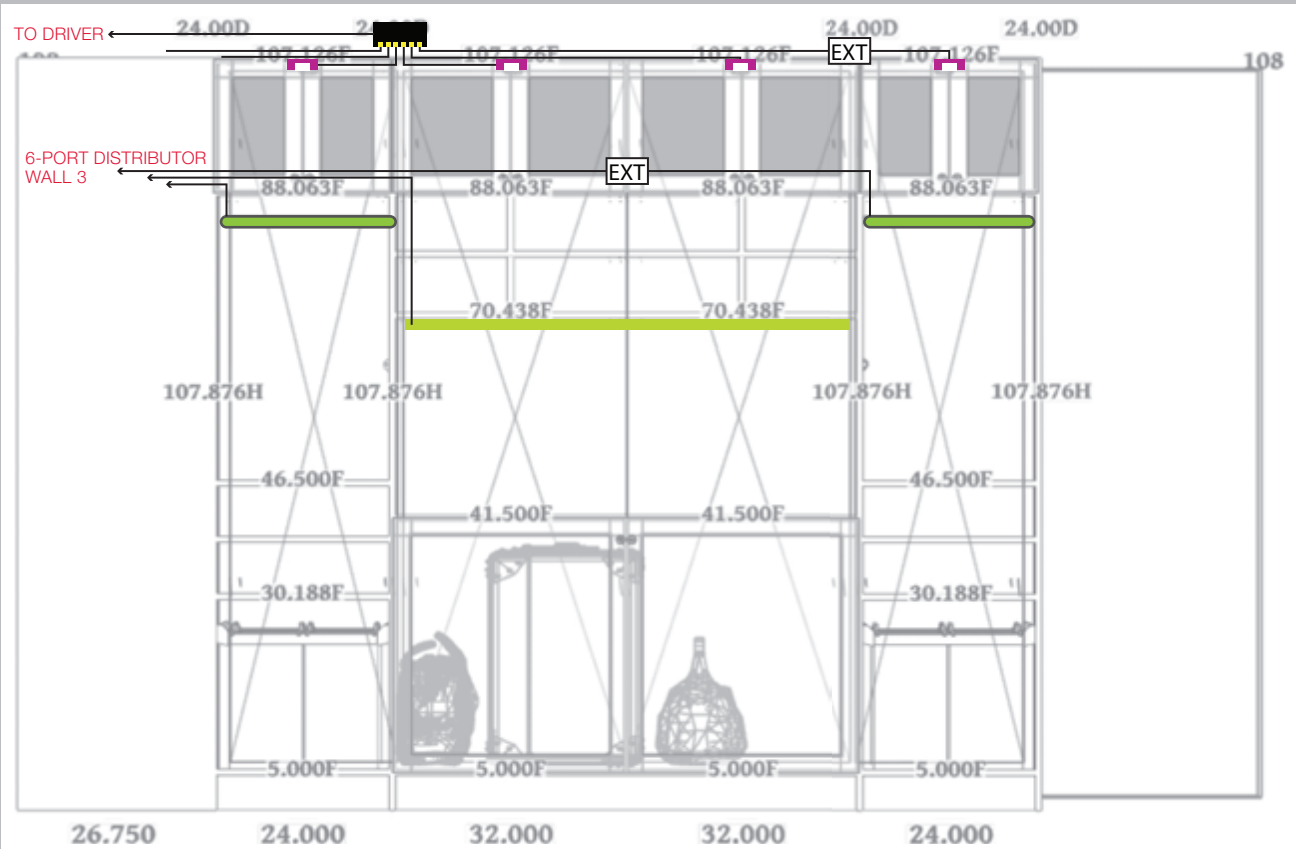

# FURNITURE & CABINET SLIDING HARDWARE

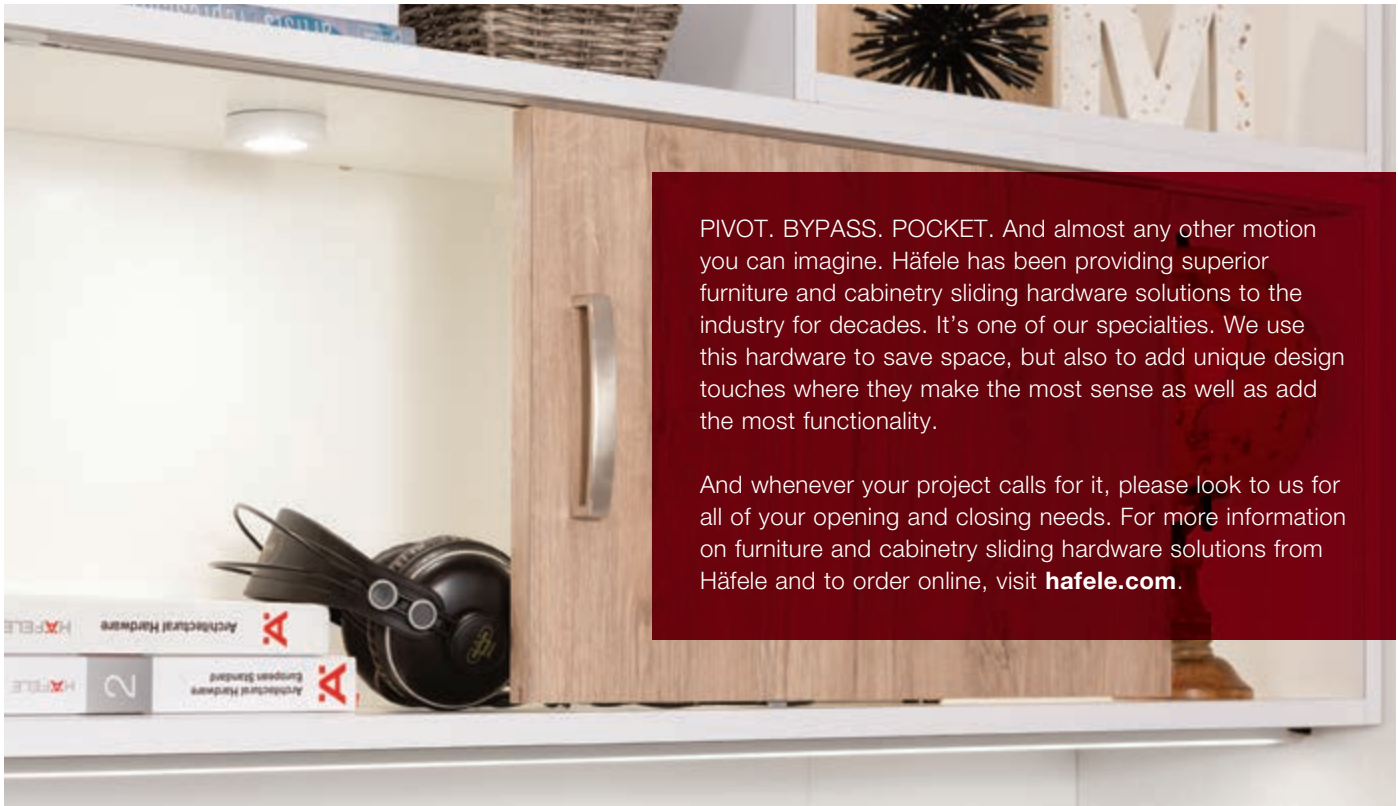

PIVOT. BYPASS. POCKET. And almost any other motion you can imagine. Häfele has been providing superior furniture and cabinetry sliding hardware solutions to the industry for decades. It's one of our specialties. We use this hardware to save space, but also to add unique design touches where they make the most sense as well as add the most functionality.

And whenever your project calls for it, please look to us for all of your opening and closing needs. For more information on furniture and cabinetry sliding hardware solutions from Häfele and to order online, visit [hafele.com](https://www.hafele.com).

## HÄFELE SLIDO R-ALUFLEX 80A



A CUSTOM-SIZED ALUMINUM FRAME with unlimited infill panel and design possibilities. That's the framed elegance that is Häfele's Slido R-Aluflex 80A sliding door solution. It's ideal for bringing stylish separation to closets, rooms, cabinetry or any other project you can think of. Infill options include all manner of wood, glass, mirror or Ecoresin materials. The bottom-running system can be designed to work with single or multi-panel sliding doors. The optional soft close is also a nice touch.

For more information on Häfele's Slido R-Aluflex 80A Sliding Door Hardware and to order online, visit [hafele.com](https://www.hafele.com).



SERVICE<sup>+</sup>Service<sup>+</sup>

THE GOAL OF HÄFELE'S SERVICE<sup>+</sup> IS SIMPLE: add value to a wide range of products. Custom projects deserve innovative solutions, tailored to your needs – all with one-stop convenience. Service<sup>+</sup> encompasses a broad range of versatile products and services, all created to improve efficiencies and streamline your project planning.

For the closet industry, this includes everything from cut-to-size non-slip mats and wardrobe tubes; custom-sized drawers; custom designer-friendly project accents such as EcoDomo leather components, library ladders and much, much more.

# CUSTOM LIBRARY LADDERS

Service+

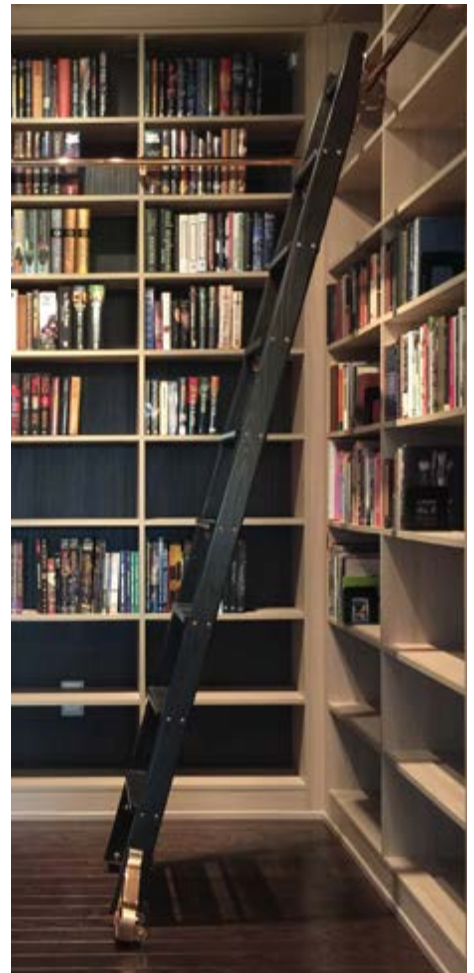

# CUSTOM LIBRARY LADDERS

**Service+**

Our custom ladders are built strong and add beauty, style and functionality to any room.

Library ladders are not only for libraries; they are also great for closets, kitchens and wine rooms.

Wood library ladders are assembled with steel rods and plated steel braces for maximum comfort and strength; all ladders incorporate a blind mounted grab bar on the top rung and a reinforced, oversize bottom step for additional strength and safety.

Track Ø: 1 1/4"

Weight capacity: 250 lbs. per ladder

Ladder weight (based on height): Wood: 4.7 lbs. per foot

Aluminum: 3.6 lbs. per foot

**Note**

Visit [www.hafele.com](http://www.hafele.com)

Services, Service+, Custom Library Ladders.



## LADDER MATERIAL OPTIONS

Ladders are available in natural hardwood or powder-coated aluminum.

### POWDER-COATED ALUMINUM

**Matte Black   Gloss Black   Beige Metallic**

**Matte White   Gloss White**

## NATURAL HARDWOOD



Birch

Cherry

Mahogany

Maple



Red Oak

White Oak

Walnut

Alder

## LADDER OPTIONS

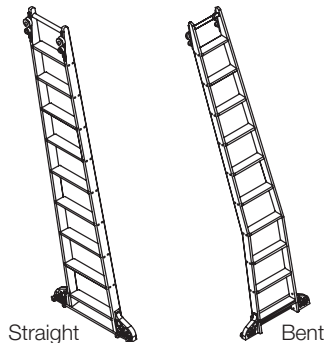

Straight

Bent

## WHEEL HOUSING OPTIONS

Contemporary

Sunburst

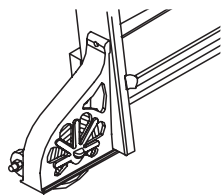
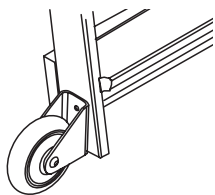

## UPPER ASSEMBLY OPTIONS

Roller Assembly for affixed rolling ladder

Hook Assembly for a removable ladder

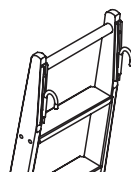
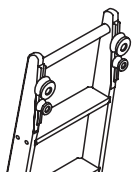

## HARDWARE OPTIONS

A variety of hardware finishes are available to complement any ladder style.

All hardware, including wheel housing, upper roller assembly, handrails, track, brackets, braces and bolts will be in the selected finish.

## PLATED HARDWARE FINISHES

**Chrome   Nickel   Copper**

**Brass   Bronze**

## POWDER-COATED HARDWARE FINISHES

**Matte Black   Gloss Black   Beige Metallic**

**Matte White   Gloss White   Silver Gray**

# ECODOMO LEATHER COMPONENTS

**Service+**



## ANDELINE COLLECTION TEXTURE AND COLORS

### Walrus

Adds a rich, nuanced and muddled look to an island, cabinet or piece of furniture. Stained with traditional leather techniques by American artisans.

### Note

Visit [www.hafele.com](http://www.hafele.com)  
Services, Service+, EcoDomo Leather.

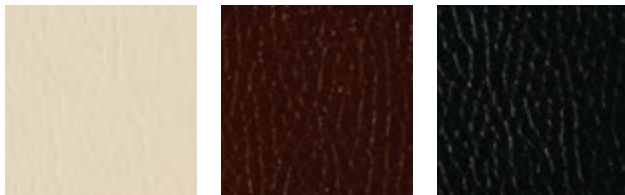

Bianco

Mahogany

Coal



Paloma Gray

Antique Grey

Antique Black



## ANDELINE COLLECTION TEXTURE AND COLORS

### Crocodile

This luxurious pattern is directional and comes standard with a synchronized, cohesive motif across all drawers, shelves and doors. You'll love how the sequence matched grain flows throughout the design.

### Note

Visit [www.hafele.com](http://www.hafele.com)  
Services, Service+, EcoDomo Leather.

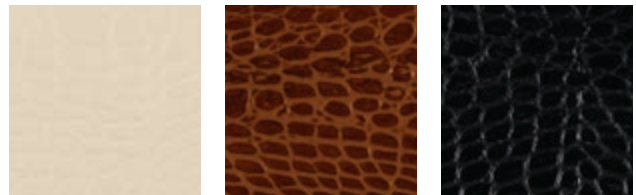

Bianco

Mahogany

Coal



Paloma Gray

Antique Grey

Antique Black

# ECODOMO LEATHER COMPONENTS

Service+

## COUNTERTOPS

Thickness: 1 1/8" or 2 3/16"

Maximum size: 44" x 94"

Leather is wrapped on the front and sides and continues 2" on the back.

Larger sizes are available, but will have seams.

Particle board core.

**Note**

Waterfall design available on special request.



## DOORS

Thickness: 3/4"

Maximum size: 44" x 96"

MDF core.

Choice of options: Infinity style: Leather is wrapped on all six sides for seamless beauty from every perspective

Penta style: Leather on five sides with a coordinating melamine back

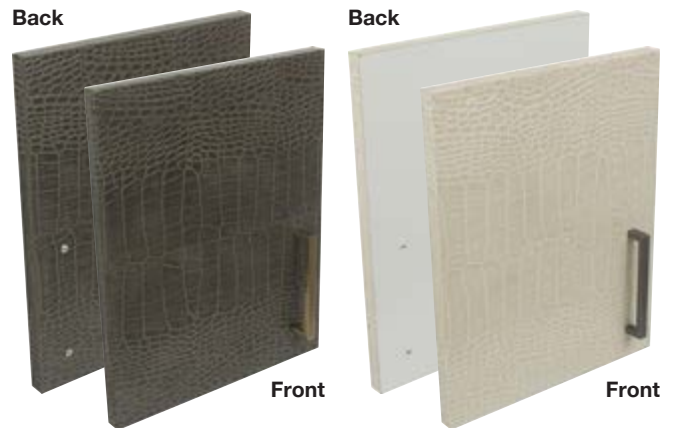

# ECODOMO LEATHER COMPONENTS

Service+

## DRAWER FRONTS

Thickness: 3/4"

MDF core.

Options: Infinity style:

Leather is wrapped on all six sides for seamless beauty from every perspective.  
Maximum size: 44" x 96"

Penta style:

Leather on five sides with a coordinating melamine back.  
Maximum size: 44" x 96"

Kensington style:

Leather is wrapped on the front and sides, and continues 2" onto the back leaving exposed MDF.  
Designed for five-sided drawers where the back of the drawer front is not visible.  
Maximum size: 26" x 96"



## INSERT PANELS

MDF core.

Thickness: 3/16" or 1/4"

Maximum size: 48" x 96"

Leather is wrapped on the front and the back.



## DRAWER LINERS

Phenolic core: 1/16"

Thickness: 3/32"

Maximum size: 48" x 96"

Top of leather liner: 1/16"



## SHELVES

Thickness: 3/4" (MDF) or 1 1/8" (particle board)

Maximum size: 24" x 96"

Leather is wrapped on the top, bottom and front.

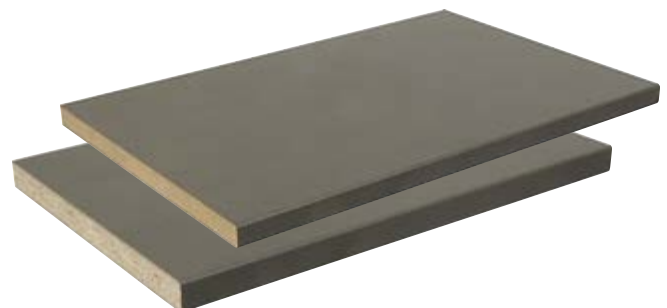

# INCEPTION VINYL COMPONENTS

Service+

The look of leather without the cost.  
Strong resistance to wear, stains and abrasion.  
Easy maintenance with most standard household cleaners.

**Note**

Visit [www.hafele.com](http://www.hafele.com)  
Services, Service+, Inception Vinyl.



## ARCADIA COLLECTION TEXTURE AND COLORS

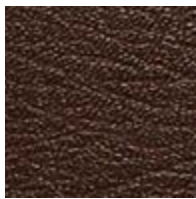

Brick



Egg Shell

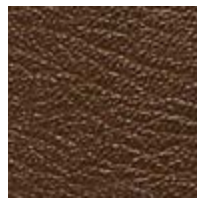

Gingerbread

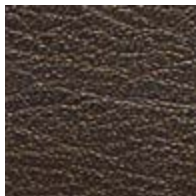

Hickory



Honey Cake



Linen

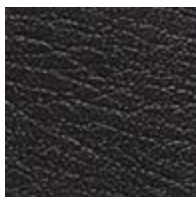

Raven

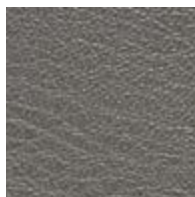

Timeless Grey

## BISCAYNE COLLECTION TEXTURE AND COLORS



Alabaster

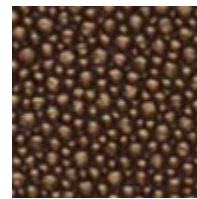

Copper Illusion



Galena

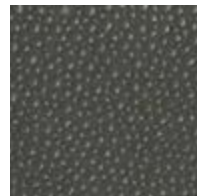

Graphite



Inkwell



Nacre

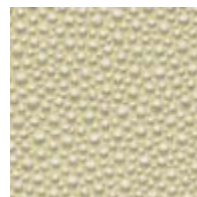

Steel

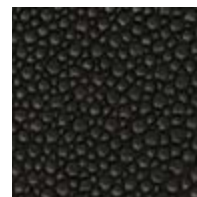

Tawny

# INCEPTION VINYL COMPONENTS

Service+

## COUNTERTOPS

Particle board core.

Thickness: 1 1/8"

Maximum size: 48" x 144"

Vinyl is wrapped on the front and sides and continues 2" on the back.

Larger sizes are available, but will have seams.

### Note

Waterfall design available on special request.



## DOORS

Thickness: 3/4"

Maximum size: 46" x 96"

MDF core.

Kensington Style: Vinyl is wrapped on five sides; includes a backside panel overlay.





# INCEPTION VINYL COMPONENTS

Service+

## DRAWER FRONTS

Thickness: 3/4" thickness

Maximum size: 26" x 96"

MDF core.

Kensington Style: Vinyl is wrapped on the front and sides, and continues 2" onto the back leaving exposed MDF. Designed for five-sided drawers where the back of the drawer front is not visible.



## SHELVES

Thickness: 3/4" (MDF) or 1 1/8" (particle board)

Maximum size: 24" x 96"

Vinyl is wrapped on the top, bottom and front.



## INSERT PANELS

Thickness: 5/32" or 1/4"

Maximum size: 48" x 96"

MDF core.

Vinyl is wrapped on the front and back.



## DRAWER LINERS

Thickness: 3/32"

Maximum size: 48" x 96"

Phenolic core: 1/16"

Top of leather liner: 1/16"



# WARDROBE FITTINGS





One signature style. Many, stylish coordinating finishes to choose from. The partnership between TAG Hardware and Häfele gives designers an option which others in our industry simply cannot match: a complete agreement of style and function across a diverse range of products. That means that an ENGAGE pant rack in a slate finish perfectly matches the slate Symphony Wall Mount Organizer the designer has placed on a wall opposing the closet...as well as the tie rack and illuminated shelf too. And that matters to owners. Especially too when it all functions and performs just as beautifully as it looks.

Available TAG Hardware product finishes include matt aluminum, chrome, matt nickel, matt gold, slate and black. And we can promise you that any one of them will make your closet project wow.

# HOW TO USE TAG HARDWARE'S SYMPHONY IN YOUR DESIGNS

The TAG Hardware Symphony Wall Mount Organizer from Häfele presents a tremendous opportunity for storage in practically any space. Truly its only limits are your creativity. Whether you have a multi-purpose use in mind like coats, shoes and accessories or a more singular purpose like ties, belts or scarves in mind, Symphony is designed to work with you, your needs and your space.



Scan the QR image for design tips and inspiration.



# TAG SYMPHONY

- > A range of widths and heights for various applications
- > Smaller sizes are ideal for partitions or a closet back panel
- > Bold metal finishes and soft vegan leather options
- > Comprised of mixed materials, adding texture and dimension to its aesthetic design
- > Hooks can be placed anywhere along the horizontal bars and can easily be reconfigured to adapt to changing storage needs
- > Attaches into drywall or a vertical panel; no studs required
- > The maximum weight capacity is 50 lbs. per horizontal bar and 200 lbs. total for a system, evenly distributed



## Metal

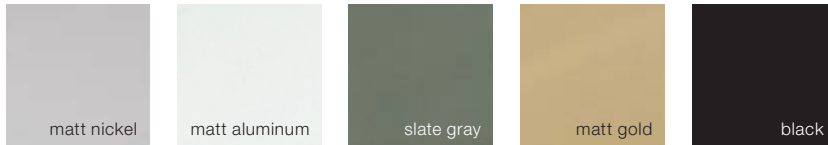

## Leather

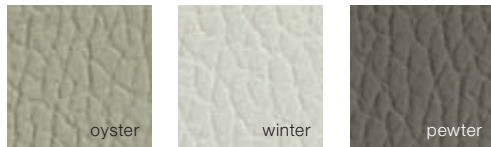

Scan the QR image for design tips and inspiration.

Lengths	Widths			
	342 (13 1/2")	584 (23")	889 (35")	1194 (47")
483 (19")	[Diagram]	[Diagram]	[Diagram]	[Diagram]
1082 (42 5/8")	[Diagram]	[Diagram]	[Diagram]	[Diagram]
1682 (66 1/4")	[Diagram]	[Diagram]	[Diagram]	[Diagram]

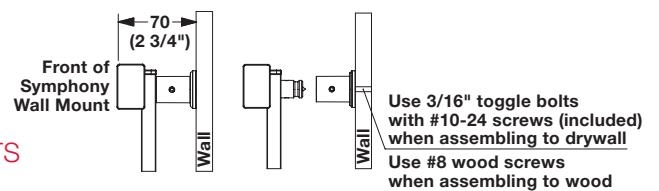

## SYMPHONY FRAME KITS

> Height: 19"

### Material

Aluminum/Vegan Leather

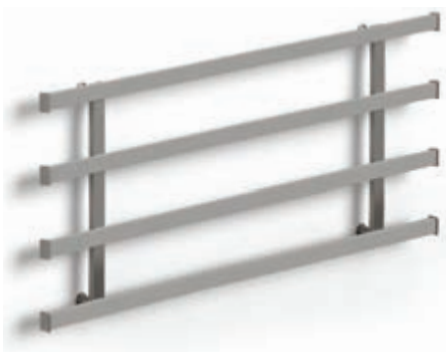

Metal finish	Leather color	Width			
		13 1/2"	23"	35"	47"
matt nickel	oyster	807.73.002	807.73.001	807.73.000	807.73.602
	winter	807.73.601	807.73.600	807.73.802	807.73.801
	pewter	807.73.800	807.73.302	807.73.301	807.73.300
matt aluminum	oyster	807.73.012	807.73.011	807.73.010	807.73.612
	winter	807.73.611	807.73.610	807.73.812	807.73.811
	pewter	807.73.810	807.73.312	807.73.311	807.73.310
slate gray	oyster	807.73.022	807.73.021	807.73.020	807.73.622
	winter	807.73.621	807.73.620	807.73.822	807.73.821
	pewter	807.73.320	807.73.822	807.73.821	807.73.820
matt gold	oyster	807.73.032	807.73.031	807.73.030	807.73.632
	winter	807.73.631	807.73.630	807.73.832	807.73.831
	pewter	807.73.830	807.73.332	807.73.331	807.73.330
black	oyster	807.71.310	807.71.311	807.71.312	807.71.313
	winter	807.71.810	807.71.811	807.71.812	807.71.813
	pewter	807.71.610	807.71.611	807.71.612	807.71.613
Recommended # of Hooks		4	8	12	16

### Supplied With

4 horizontal bars, 2 vertical mounts, Mounting hardware

### Note

Order hooks separately, see page 22.

# TAG SYMPHONY



## SYMPHONY FRAME KITS

> Height: 42 5/8"

### Material

Aluminum/Vegan Leather



Metal finish	Leather color	Width			
		13 1/2"	23"	35"	47"
matt nickel	oyster	807.73.042	807.73.041	807.73.040	807.73.642
	winter	807.73.641	807.73.640	807.73.842	807.73.841
	pewter	807.73.840	807.73.342	807.73.341	807.73.340
matt aluminum	oyster	807.73.052	807.73.051	807.73.050	807.73.652
	winter	807.73.651	807.73.650	807.73.852	807.73.851
	pewter	807.73.850	807.73.352	807.73.351	807.73.350
slate gray	oyster	807.74.002	807.74.001	807.74.000	807.74.602
	winter	807.74.601	807.74.600	807.74.802	807.74.801
	pewter	807.74.800	807.74.302	807.74.301	807.74.300
matt gold	oyster	807.73.062	807.73.061	807.73.060	807.73.662
	winter	807.73.661	807.73.660	807.73.862	807.73.861
	pewter	807.73.860	807.73.362	807.73.361	807.73.360
black	oyster	807.71.320	807.71.321	807.71.322	807.71.323
	winter	807.71.820	807.71.821	807.71.822	807.71.823
	pewter	807.71.620	807.71.621	807.71.622	807.71.623
Recommended # of Hooks		8	12	16	20

**Supplied With** 8 horizontal bars, 2 vertical mounts, Mounting hardware

**Note** Order hooks separately, see page 22.



## SYMPHONY FRAME KITS

> Height: 66 1/4"

### Material

Aluminum/Vegan Leather

Metal finish	Leather color	Width			
		13 1/2"	23"	35"	47"
matt nickel	oyster	807.74.012	807.74.011	807.74.010	807.74.612
	winter	807.74.611	807.74.610	807.74.812	807.74.811
	pewter	807.74.810	807.74.312	807.74.311	807.74.310
matt aluminum	oyster	807.73.072	807.73.071	807.73.070	807.73.672
	winter	807.73.671	807.73.670	807.73.872	807.73.871
	pewter	807.73.870	807.73.372	807.73.371	807.73.370
slate gray	oyster	807.74.022	807.74.021	807.74.020	807.74.622
	winter	807.74.621	807.74.620	807.74.822	807.74.821
	pewter	807.74.820	807.74.322	807.74.321	807.74.320
matt gold	oyster	807.73.082	807.73.081	807.73.080	807.73.682
	winter	807.73.681	807.73.680	807.73.882	807.73.881
	pewter	807.73.880	807.73.382	807.73.381	807.73.380
black	oyster	807.71.330	807.71.331	807.71.332	807.71.333
	winter	807.71.830	807.71.831	807.71.832	807.71.833
	pewter	807.71.630	807.71.631	807.71.632	807.71.633
Recommended # of Hooks		12	16	20	24

**Supplied With** 12 horizontal bars, 2 vertical mounts, Mounting hardware

**Note** Order hooks separately, see page 22.

# TAG SYMPHONY

Hooks can be placed anywhere along the horizontal bars and can easily be reconfigured to adapt to changing storage needs. The hooks project only a short distance from the organizer, allowing it to fit behind doors or in areas with limited space.

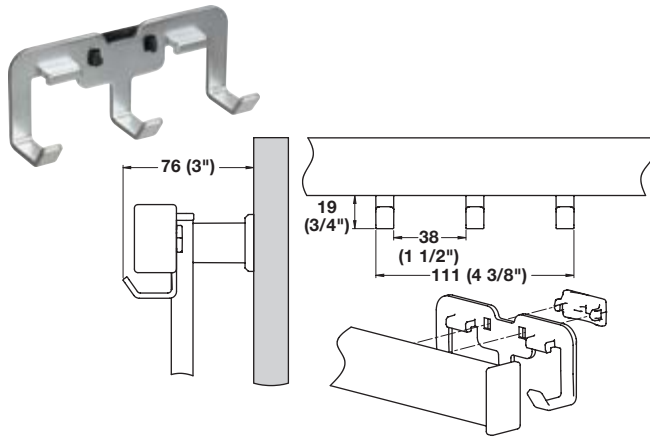

## TRIPLE HOOKS

> Maximum weight capacity: 10 lbs.

### Material

Aluminum

Finish	Item No.
matt aluminum	807.72.050
matt nickel	807.72.650
matt gold	807.72.850
slate	807.72.350
black	807.72.250

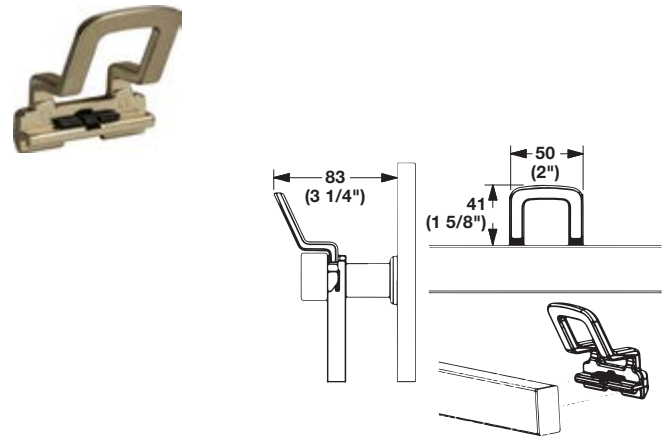
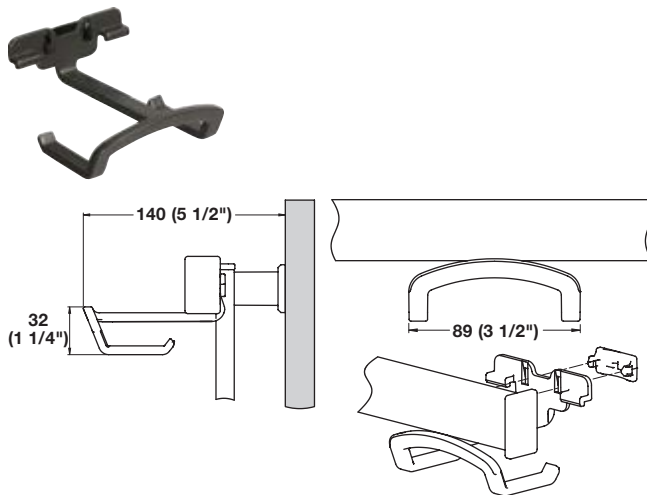

## COAT HOOKS

> Maximum weight capacity: 20 lbs.

### Material

Aluminum

Finish	Item No.
matt aluminum	807.72.030
matt nickel	807.72.630
matt gold	807.72.830
slate	807.72.330
black	807.72.230

## SHOE HOOKS

> Maximum weight capacity: 10 lbs.

### Material

Aluminum

Finish	Item No.
matt aluminum	807.72.060
matt nickel	807.72.660
matt gold	807.72.860
slate	807.72.360
black	807.72.260

# THE PERFECT MATCH

A coordinated look and consistency of function in the closet are now the expectation. And Häfele's range of TAG Hardware components is the only solution on the market today which achieves this – and does so – in spectacular fashion.

The closet is exactly where the details – a valet pin which matches the scarf rack, belt rack and folding station pull-out – matter the most. Because no one ever envisions a dream closet with components coming from six different companies, four varying degrees of the same finish and one thing which looks entirely out of place.

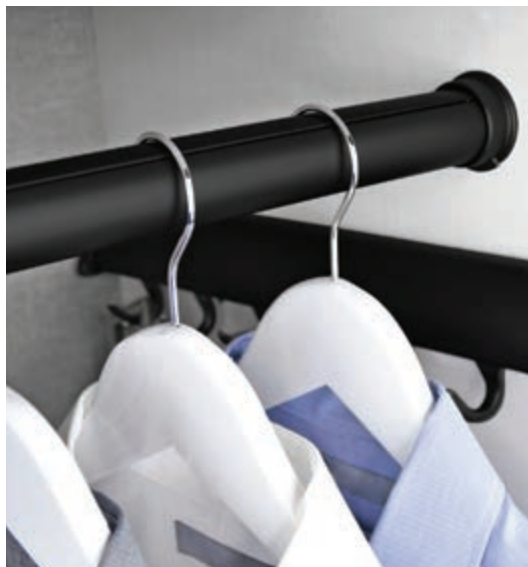



# TAG ENGAGE

See coordinating TAG Decorative Hardware on pages 150–154.



## PULL-OUT SHELVES

- > For use as Jewelry Organizers, Divided Shelves or Folding Stations
- > Fabric lined
- > Full extension
- > Soft closing
- > H x D: 2 3/16" x 13 7/8"

**Material**

Aluminum/Fabric



Width	matt aluminum, slate	matt gold, beach	matt nickel, slate	black, beach	slate, slate
18"	807.77.001	807.77.901	807.77.601	807.78.301	807.78.101
24"	807.77.002	807.77.902	807.77.602	807.78.302	807.78.102
30"	807.77.003	807.77.903	807.77.603	807.78.303	807.78.103
36"	807.77.004	807.77.904	807.77.604	807.78.304	807.78.104

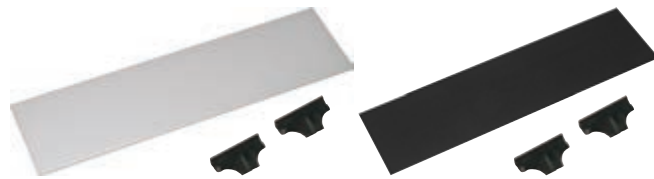

## SHELF DIVIDERS WITH CLIPS

- > For use with pull-out shelf
- > W x D x H: 12 11/16" x 3 1/8" x 1 5/8"

**Material**

Aluminum

Finish	Item No.
matt aluminum	807.77.699
matt gold	807.77.999
matt nickel	807.77.199
black	807.78.599
slate	807.77.299



## DRAWER FACE ADAPTERS, OPTIONAL

- > Allows a drawer front to be attached to the pull-out frame
- > Drawer front height: max. 5"
- > Conceals the frame and dividers, while adding a place to install a lock
- > W x D x H: 2 3/8" x 2 15/16" x 1/8"

**Material**

Steel

Finish	Item No.
white	807.77.796
black	807.77.596

**Note**

Cannot be used with the pant organizer on page 30.

# TAG ENGAGE

See coordinating TAG Decorative Hardware on pages 150–154.



## JEWELRY ORGANIZERS

- > For use with pull-out shelf
- > H x D: 15/16" x 12"

**Material**  
Aluminum

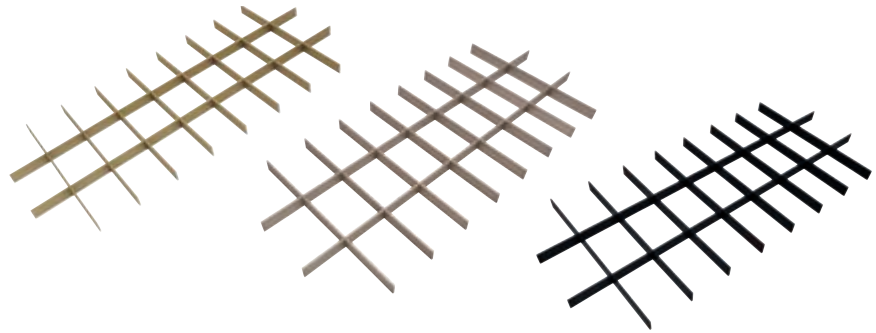

Pull-out shelf	Width	matt aluminum	matt gold	matt nickel	black	slate
18"	14 13/16"	807.77.081	807.77.981	807.77.681	807.78.581	807.77.281
24"	20 13/16"	807.77.082	807.77.982	807.77.682	807.78.582	807.77.282
30"	26 13/16"	807.77.083	807.77.983	807.77.683	807.78.583	807.77.283
36"	32 13/16"	807.77.084	807.77.984	807.77.684	807.78.584	807.77.284

# TAG ENGAGE

See coordinating TAG Decorative Hardware on pages 150–154.



## LINGERIE DRAWERS

- > Designed specifically to organize more lingerie in less space
- > Fabric dividers allow for completely customizable compartments
- > Full extension
- > Soft closing
- > H x D: 5" x 13 7/8"

### Material

Aluminum/Fabric

Width	# of dividers	matt aluminum, slate	matt gold, beach	matt nickel, slate	black, beach	slate, slate
18"	2	807.77.011	807.77.911	807.77.611	807.78.311	807.78.111
24"	3	807.77.012	807.77.912	807.77.612	807.78.312	807.78.112
30"	4	807.77.013	807.77.913	807.77.613	807.78.313	807.78.113
36"	5	807.77.014	807.77.914	807.77.614	807.78.314	807.78.114



## ADDITIONAL LINGERIE DRAWER DIVIDERS

> W x D x H: 13" x 1 5/8" x 2 7/8"

### Material

Fabric

Color	Item No.
slate	807.77.491
beach	807.77.391

# TAG ENGAGE

See coordinating TAG Decorative Hardware on pages 150–154.



## DEEP DRAWERS

- > A sophisticated bulk storage solution specifically for the closet
- > Fabric dividers allow for completely customizable compartments
- > Full extension
- > Soft closing
- > H x D: 8 15/16" x 13 7/8"

### Material

Aluminum/Fabric



Width	# of dividers	matt aluminum, slate	matt gold, beach	matt nickel, slate	black, beach	slate, slate
18"	1	807.77.021	807.77.921	807.77.621	807.78.321	807.78.121
24"	2	807.77.022	807.77.922	807.77.622	807.78.322	807.78.122
30"	2	807.77.023	807.77.923	807.77.623	807.78.323	807.78.123
36"	2	807.77.024	807.77.924	807.77.624	807.78.324	807.78.124



## ADDITIONAL DEEP DRAWER DIVIDERS

> W x D x H: 13" x 1 5/8" x 6 3/4"

### Material

Fabric

Color	Item No.
slate	807.77.492
beach	807.77.392

# TAG ENGAGE

See coordinating TAG Decorative Hardware on pages 150–154.

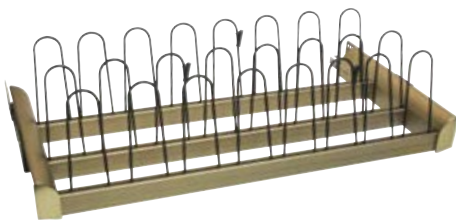

## SHOE ORGANIZERS

- > Perfect solution to utilize closet depth and allow easy access
- > Front clips convert the first row into sandal storage
- > H x D: 7 1/2" x 13 7/8"

### Material

Aluminum

Width	# of clips	matt aluminum	matt gold	matt nickel	black	slate
18"	4	807.77.071	807.77.971	807.77.671	807.77.571	807.77.271
24"	6	807.77.072	807.77.972	807.77.672	807.77.572	807.77.272
30"	8	807.77.073	807.77.973	807.77.673	807.77.573	807.77.273
36"	10	807.77.074	807.77.974	807.77.674	807.77.574	807.77.274

## STORAGE BOXES

- > Fits perfectly on the top shelf of an 86" high closet with an 8' ceiling
- > H x D: 7 3/8" x 13 1/2"

### Material

Fabric



Width	slate	beach
14 1/2"	807.77.460	807.77.360
17 1/2"	807.77.461	807.77.361
23 1/2"	807.77.462	807.77.362

# TAG ENGAGE

See coordinating TAG Decorative Hardware on pages 150–154.



## LAUNDRY ORGANIZERS

- > Beautiful, deep, removable laundry bags in 4 widths
- > Bags are simple to remove and carry to the laundry room with one hand
- > Full extension
- > Soft closing
- > Frame: H x D: 2 13/16" x 13 7/8"

### Material

Aluminum



Width	Bags	matt aluminum/ slate bags	matt nickel/ slate bags	black/ beach bags	matt gold/ beach bags	slate/ slate bags
18"	1 x 18"	807.81.410	807.81.510	807.82.320	807.81.920	807.81.710
24"	2 x 12"	807.81.411	807.81.511	807.82.321	807.81.921	807.81.711
30"	2 x 15"	807.81.412	807.81.512	807.82.322	807.81.922	807.81.712
36"	2 x 18"	807.81.413	807.81.513	807.82.323	807.81.923	807.81.713

### Supplied With

Frame and laundry bags



## LAUNDRY BAGS

- > For use with pull-out frame
- > H x D: 18 3/4" x 11"

### Material

Fabric

Width	slate	beach
12"	807.77.440	807.77.340
15"	807.77.441	807.77.341
18"	807.77.442	807.77.342

### Note

Bag width is approximate.

# TAG ENGAGE

See coordinating TAG Decorative Hardware on pages 150–154.



## PANT ORGANIZERS

- > Plastic strips allow the pant hangers to glide effortlessly
- > Garment clips can be added to hangers for hanging skirts or pants by the cuff
- > Full extension
- > Soft closing
- > Frame: H x D: 2 13/16" x 13 7/8"

**Material**

Aluminum

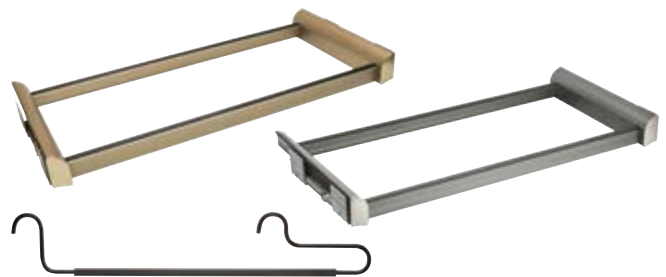

Width	# of hangers	matt aluminum	matt nickel	black	matt gold	slate
18"	12	807.81.000	807.81.600	807.82.500	807.81.900	807.81.200
24"	18	807.81.001	807.81.601	807.82.501	807.81.901	807.81.201
30"	24	807.81.002	807.81.602	807.82.502	807.81.902	807.81.202
36"	30	807.81.003	807.81.603	807.82.503	807.81.903	807.81.203

**Supplied With**

Frame hangers

**Note**

Cannot be used with the drawer face adapter on page 24.

## WIRE PANT HANGER

- > For pant frame organizer



**Material**

Steel, powder-coated

Finish	Item No.
black	805.58.332

## GARMENT CLIP

- > Attaches to hangers for skirts, pants, etc.



**Material**

Plastic

Color	Item No.
black	805.58.331

# TAG SIGNATURE COLLECTION

See coordinating TAG Decorative Hardware on pages 150–154.

**Service+**



## WARDROBE TUBES WITH SUPPORTS

- > Protective cap reduces noise and prevents scratching
- > D x H: 3/4" x 1 1/4"

**Material**

Tube: Aluminum, anodized; Cap: Plastic  
End supports: Zinc-plated



Length	Finish/Cap					
	matt gold/ clear	polished chrome/ clear	matt aluminum/ clear	matt nickel/ clear	black/ black	slate/ black
17 3/4"	801.78.991	801.78.291	801.78.491	801.78.691	801.78.715	801.78.391
23 3/4"	801.78.992	801.78.292	801.78.492	801.78.692	801.78.716	801.78.392
29 3/4"	801.78.993	801.78.293	801.78.493	801.78.693	801.78.717	801.78.393
35 3/4"	801.78.994	801.78.294	801.78.494	801.78.694	801.78.718	801.78.394
47 15/16"	801.78.995	801.78.295	801.78.495	801.78.695	801.78.719	801.78.395



# TAG SIGNATURE COLLECTION

See coordinating TAG Decorative Hardware on pages 150–154.



## WARDROBE TUBES

- > Protective cap reduces noise and prevents scratching.
- > Tube can be mounted to partitions or suspended from a shelf.
- > D x H x L: 3/4" x 1 1/4" x 8'



**Material**

Aluminum; Cap: Plastic

Finish/Cap	Item No.
matt gold/clear	801.78.912
polished chrome/clear	801.78.212
matt aluminum/clear	801.78.412
matt nickel/clear	801.78.612
black/black	801.78.712
slate/black	801.78.312

## END SUPPORTS

- > W x H: 1 1/4" x 1 3/4"



**Material**

Zinc

Finish	Item No.
matt gold	803.39.950
polished chrome	803.39.250
matt aluminum	803.39.450
matt nickel	803.64.650
black	803.64.450
slate	803.39.750

## CENTER SUSPENDED SUPPORTS

- > W x H: 1 1/4" x 3 5/8"



**Material**

Zinc

Finish	Item No.
matt gold	802.13.900
polished chrome	802.13.200
matt aluminum	802.13.000
matt nickel	802.13.600
black	802.13.500
slate	802.13.300

## SUSPENDED SUPPORTS

- > W x H: 1 1/4" x 3 5/8"



**Material**

Zinc

Finish	Item No.
matt gold	803.64.900
polished chrome	803.64.200
matt aluminum	803.64.000
matt nickel	803.64.600
black	803.64.500
slate	803.64.300

# TAG SYNERGY ELITE

See coordinating TAG Decorative Hardware on pages 150–154.

**Service+**



## WARDROBE TUBES WITH SUPPORTS

- > Round with protective insert on top
- > Ø: 1 5/16"

**Material**

Tube: Aluminum, anodized; Insert: Plastic

End supports: Zinc-plated

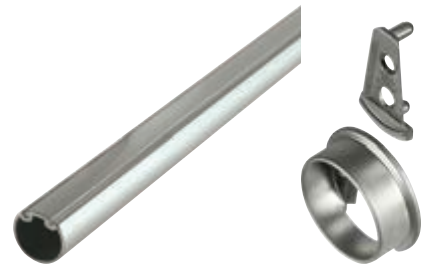

Length	Finish/Insert					
	matt gold/ clear	polished chrome/ clear	matt aluminum/ clear	matt nickel/ clear	black/ black	slate/ black
17 3/4"	801.42.055	801.42.255	801.42.465	801.42.655	801.43.345	801.42.355
23 3/4"	801.42.056	801.42.256	801.42.466	801.42.656	801.43.346	801.42.356
29 3/4"	801.42.057	801.42.257	801.42.467	801.42.657	801.43.347	801.42.357
35 3/4"	801.42.058	801.42.258	801.42.468	801.42.658	801.43.348	801.42.358
47 15/16"	801.42.059	801.42.259	801.42.469	801.42.659	801.43.349	801.42.359

# TAG SYNERGY ELITE

See coordinating TAG Decorative Hardware on pages 150–154.



## ALUMINUM WARDROBE TUBES

- > Round with protective insert on top
- > Ø x L: 1 5/16" x 8'

### Material

Aluminum, anodized; Insert: Plastic



Finish/Insert	Item No.
matt gold/clear	801.42.040
polished chrome/clear	801.42.240
matt aluminum/clear	801.42.440
matt nickel/clear	801.42.640
black/black	801.43.340
slate/black	801.42.340

## VEGAN LEATHER WARDROBE TUBES

- > Round with protective insert
- > Ø x L: 1 5/16" x 35 3/4"

### Material

Vegan Leather; Insert: Plastic



Vegan Leather Color/Insert	Item No.
winter/sandstone	801.81.700
oyster/sandstone	801.81.400
pewter/sandstone	801.81.500

## END SUPPORTS

- > Two-part design allows the support to fully surround the tube
- > 32 mm spacing with an additional screw hole for side panel mounting



### Material

Zinc-plated

Finish	Item No.
matt gold	803.39.910
polished chrome	803.39.210
matt aluminum	803.39.410
matt nickel	803.39.610
black	803.64.410
slate	803.39.710

## WARDROBE TUBE CENTER SUPPORTS

- > Surface mount
- > For Ø1 5/16" tube



### Material

Zinc die-cast

Finish	Item No.
matt gold	802.06.067
polished chrome	802.06.267
matt aluminum	802.06.367
matt nickel	802.06.667
black	802.06.767
slate	802.06.467

### Supplied With

Screws

# TAG SYNERGY ELITE

See coordinating TAG Decorative Hardware on pages **150–154**.



## TIE RACKS WITH SLIDES

- > Full extension
- > W x H: 2 9/16" x 2 5/8"

### Material

Aluminum, anodized/Zinc

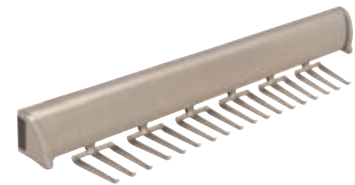

Finish	15 hook; length: 11 7/8"	18 hook; length: 13 7/8"	24 hook; length: 17 15/16"
matt gold	807.67.901	807.67.904	807.67.905
polished chrome	807.67.201	807.67.203	807.67.205
matt aluminum/chrome	807.67.401	807.67.403	807.67.405
matt nickel	807.67.601	807.67.603	807.67.605
black	807.67.501	807.67.503	807.67.505
slate	807.67.301	807.67.303	807.67.305

## BELT RACKS WITH SLIDES

- > Full extension
- > W x H: 1 5/8" x 2 13/16"

### Material

Aluminum, anodized/Zinc



Finish	5 hook; length: 11 7/8"	6 hook; length: 13 7/8"	8 hook; length: 17 15/16"
matt gold	807.67.911	807.67.913	807.67.915
polished chrome	807.67.211	807.67.213	807.67.215
matt aluminum/chrome	807.67.411	807.67.413	807.67.415
matt nickel	807.67.611	807.67.613	807.67.615
black	807.67.511	807.67.513	807.67.515
slate	807.67.311	807.67.313	807.67.315

# TAG SYNERGY ELITE

See coordinating TAG Decorative Hardware on pages 150–154.



## SCARF RACKS WITH SLIDES

- > Full extension
- > W x H: 2 3/16" x 2 9/16"

### Material

Aluminum, anodized/Zinc



Finish	5 hook; length: 11 7/8"	6 hook; length: 13 7/8"	8 hook; length: 17 15/16"
matt gold	807.67.921	807.67.923	807.67.925
polished chrome	807.67.221	807.67.223	807.67.225
matt aluminum/chrome	807.67.421	807.67.423	807.67.425
matt nickel	807.67.621	807.67.623	807.67.625
black	807.67.521	807.67.523	807.67.525
slate	807.67.321	807.67.323	807.67.325

## FIXED ACCESSORY HOOKS

- > W x H: 1 5/8" x 2 13/16"

### Material

Aluminum, anodized/Zinc



Finish	6 hook length: 15 1/4"	8 hook length: 19 1/4"
matt gold	807.67.983	807.67.985
polished chrome	807.67.283	807.67.285
matt aluminum/chrome	807.67.483	807.67.485
matt nickel	807.67.683	807.67.685
black	807.67.583	807.67.585
slate	807.67.383	807.67.385

# TAG SYNERGY ELITE

See coordinating TAG Decorative Hardware on pages **150–154**.



## VALETS

- > Mounts to the side panel
- > Weight capacity: 30 lbs. in vertical position
- > W x H: 15/16" x 15/16"

### Material

Aluminum, anodized



Finish	Length: 11 3/4"; extension: 7 9/16"	Length: 14 1/8"; extension: 9 9/16"
matt gold	808.71.001	808.71.003
polished chrome	808.71.201	808.71.203
matt aluminum/chrome	808.71.401	808.71.403
matt nickel	808.71.601	808.71.603
black	808.71.501	808.71.503
slate	808.71.301	808.71.303

## VALET PINS

- > Retracts into the partition
- > Weight capacity: 5 lbs.
- > Length: 4"
- > Extension: 1 3/4"



### Material

Aluminum

Finish	Item No.
matt gold	808.72.900
chrome	808.72.200
matt aluminum	808.72.000
matt nickel	808.72.600
black	808.72.400
slate	808.72.300

# TAG SYNERGY ELITE

See coordinating TAG Decorative Hardware on pages 150–154.



## SHOE FENCE SETS

- > For shelving, available in standard widths
- > Width can be reduced by sliding the end post off and cutting aluminum rail, re-attach post by tapping on with rubber mallet
- > Center post slides back and forth for easy positioning
- > Horizontal rails are two-sided, one being smooth and the other textured to match other Synergy Elite items



### Material

Aluminum

Width	polished chrome	matt aluminum; chrome post	matt nickel	matt gold; polished post	black	slate
11"	547.52.221	547.52.421	547.52.621	547.52.921	547.52.521	547.52.321
17"	547.52.222	547.52.422	547.52.622	547.52.922	547.52.522	547.52.322
23"	547.52.223	547.52.423	547.52.623	547.52.923	547.52.523	547.52.323
29"	547.52.224	547.52.424	547.52.624	547.52.924	547.52.524	547.52.324
35"	547.52.226	547.52.426	547.52.626	547.52.926	547.52.526	547.52.326

### Supplied With

Mounting hardware, Bar, Posts

### Note

Center post is supplied for lengths over 23".

## SHOE FENCE BARS

- > Bar can be customized to fit the shelf of your choice
- > Perfect for framing shelves, pull-out trays or creating your own shoe fence
- > Use the versatile corner posts to create unified corners on L-shaped shoe shelves, frame pull-out shelves or create your own unique design
- > Length: 93"



### Material

Aluminum

Finish	Item No.
polished chrome	547.52.240
matt aluminum	547.52.040
matt nickel	547.52.640
matt gold	547.52.940
black	547.52.540
slate	547.52.340



## POSTS FOR SHOE FENCE

- > Corner posts provide a sleek solution to framing pull-out shelves, which can be used to store shoes or display your favorite items
- > Ideal for framing floating angled shoe shelves
- > Perfect for L-shaped shelves, providing a unified corner



### Material

Aluminum

Finish	Center	End	Corner
chrome	547.52.280	547.52.290	547.52.299
matt nickel	547.52.680	547.52.690	547.52.699
matt gold	547.52.980	547.52.990	547.52.999
black	547.52.580	547.52.590	547.52.599
slate	547.52.380	547.52.390	547.52.399

### Supplied With

Mounting hardware

# TAG SYNERGY ELITE

Easy to use, pull out and rotate for full viewing.  
 Mounts with four screws.  
 Slides have detent in and out to hold mirror in place.  
 Ideal for spaces where installation is required on the outside of a panel and rotated inwards.  
 Mirror extends 6" from the front edge of the closet allowing up to 345° rotation.  
 Provides great viewing angles from almost anywhere in the closet.  
 See coordinating TAG Decorative Hardware on pages **150-154**.

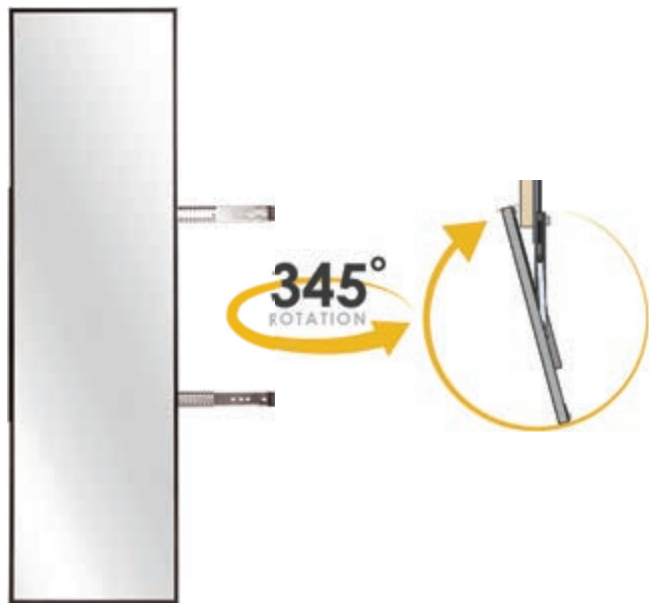

## FULL ROTATION MIRRORS

- > Length: 13 1/8"
- > Width: 35" mirror - 1 5/16"; 47" mirror - 1 1/2"

**Material**  
 Aluminum

Finish	Height: 35"	Height: 47 3/8"
matt aluminum	805.73.021	805.73.022
black	805.73.421	805.73.422
matt gold	805.73.921	805.73.922
matt nickel	805.73.621	805.73.622
slate	805.73.321	805.73.322

**Note**  
 35" mirrors allow for installation above jewelry drawers, inside upper hanging sections or anywhere you're a little short on space.

## FIXED MIRRORS

- > Slim, full frame mirror features a low profile design
- > Perfect for unused wall space or behind a door
- > Style and finish coordinate perfectly with all Synergy Elite and Synergy accessories
- > W x D: 13 1/8" x 5/8"

**Material**  
 Aluminum

Finish	Height: 35"	Height: 47 3/8"
matt aluminum	805.73.011	805.72.030
black	805.73.411	805.72.430
matt gold	805.73.911	805.72.930
matt nickel	805.73.611	805.72.630
slate	805.73.311	805.72.330

**Supplied With**  
 Locking and installation hardware



# TAG SYNERGY ELITE

## CLEAT SYSTEM

Hooks are used on customer supplied boards.  
See coordinating TAG Decorative Hardware on pages **150-154**.



### TIE HOOKS

- > Holds 8 ties
- > L x W x H: 3 3/4" x 2 3/8" x 5 1/4"



**Material**  
Zinc

Finish	Item No.
matt gold	807.69.901
polished chrome	807.69.200
matt aluminum	807.69.000
matt nickel	807.69.600
black	807.68.300
slate	807.69.370

### WATERFALL HOOKS

- > Each hook holds 3 coat hangers
- > L x W x H: 3 3/4" x 1/2" x 6 1/2"



**Material**  
Zinc

Finish	Item No.
matt gold	807.69.960
polished chrome	807.69.260
matt aluminum	807.69.060
matt nickel	807.69.660
black	807.68.360
slate	807.69.360

### BELT HOOKS

- > Holds 5 belts
- > L x W x H: 3 1/16" x 3 1/8" x 5 1/8"



**Material**  
Zinc

Finish	Item No.
matt gold	807.69.920
polished chrome	807.69.220
matt aluminum	807.69.020
matt nickel	807.69.620
black	807.68.320
slate	807.69.320

# TAG SYNERGY ELITE

## CLEAT SYSTEM

Hooks are used on customer supplied boards.  
See coordinating TAG Decorative Hardware on pages **150-154**.



### COAT HOOKS

- > L x W x H: 1 1/2" x 3 5/8" x 6 1/4"
- > Compact Hooks: L x W x H: 1 1/16" x 2 3/4" x 4 1/2"



**Material**

Zinc

Finish	Coat Hook	Compact Coat Hook
matt gold	807.69.930	807.69.931
polished chrome	807.69.230	807.69.231
matt aluminum	807.69.030	807.69.031
matt nickel	807.69.630	807.69.631
black	807.68.330	807.68.331
slate	807.69.330	807.69.331

### BROOM HOOKS

- > For long handle items
- > L x W x H: 1 3/8" x 7/8" x 4 5/16"



**Material**

Zinc

Finish	Item No.
matt gold	807.69.950
polished chrome	807.69.250
matt aluminum	807.69.050
matt nickel	807.69.650
black	807.68.350
slate	807.69.350

### DOUBLE HOOKS

- > L x W x H: 3 1/2" x 2 1/2" x 2 5/8"



**Material**

Zinc

Finish	Item No.
matt gold	807.69.940
polished chrome	807.69.240
matt aluminum	807.69.040
matt nickel	807.69.640
black	807.68.340
slate	807.69.340

# TAG SYNERGY

See coordinating TAG Decorative Hardware on pages 150–154.



## WARDROBE TUBES WITH SUPPORTS, ROUND

> Ø: 1 5/16"

### Material

Aluminum, anodized

**Service+**



Length	polished chrome	matt aluminum	matt nickel	black
17 3/4"	801.42.235	801.42.935	801.42.635	830.28.830
23 3/4"	801.42.236	801.42.936	801.42.636	830.28.831
29 3/4"	801.42.237	801.42.937	801.42.637	830.28.832
35 3/4"	801.42.238	801.42.938	801.42.638	830.28.833
47 15/16"	801.42.234	801.42.934	801.42.634	830.28.834

## WARDROBE TUBES, ROUND

> Ø x L: 1 5/16" x 8'

### Material

Aluminum, anodized or powder-coated



Finish	Item No.
polished chrome	801.42.200
matt aluminum	801.42.900
matt nickel	801.42.600
black	830.28.715
white powder-coated	801.42.710

## END SUPPORTS

> 1 1/4" spacing with an additional screw hole for side panel mounting

### Material

Zinc-plated



Finish	Item No.
polished chrome	803.56.200
matt aluminum	803.56.900
matt nickel	803.56.600
black	803.56.300
white powder-coated	803.56.710

## CENTER SUPPORTS

> Surface mount; fits Ø1 5/16" tube

### Material

Zinc die-cast



Finish	Item No.
polished chrome	802.06.267
matt aluminum	802.06.367
matt nickel	802.06.667
black	802.06.767

# TAG SYNERGY

See coordinating TAG Decorative Hardware on pages 150–154.

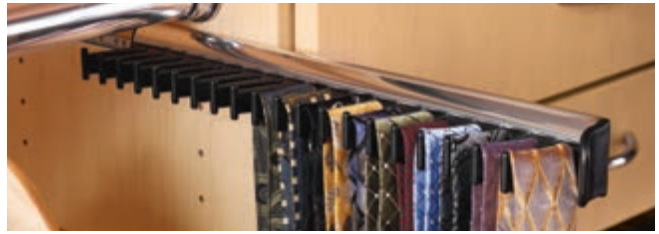

## TIE RACKS WITH SLIDES, 3/4 EXTENSION

> W x H: 2 3/16" x 1 11/16"

### Material

Aluminum, anodized or powder-coated

Finish	20 hook length: 14 1/8"	17 hook length: 11 15/16"
polished chrome	807.54.233	807.54.232
matt aluminum	807.54.933	807.54.932
matt nickel	807.54.633	807.54.632
black	807.54.333	807.54.332
white powder-coated	807.54.773	807.54.772



## BELT RACKS WITH SLIDES, 3/4 EXTENSION

> W x H: 2 3/16" x 1 11/16"

### Material

Aluminum, anodized or powder-coated

Finish	6 hook length: 14 1/8"	5 hook length: 11 15/16"
polished chrome	807.54.231	807.54.230
matt aluminum	807.54.931	807.54.930
matt nickel	807.54.631	807.54.630
black	807.54.331	807.54.330
white powder-coated	807.54.771	807.54.770

# TAG SYNERGY

See coordinating TAG Decorative Hardware on pages 150–154.



## SCARF RACKS WITH SLIDES

- > 3/4 extension with 6 hooks
- > L x W x H: 14 1/8" 2 3/8" x 1 11/16"

**Material**

Aluminum, anodized

Finish	Item No.
polished chrome	807.54.234
matt aluminum	807.54.934
matt nickel	807.54.634
black	807.54.334



## VALETS

- > Mounts to the partition
- > Weight capacity: 30 lbs. in vertical position
- > W x H: 1 1/16" x 1 7/8"

**Material**

Aluminum, anodized or powder-coated

Finish	Length: 14 1/4"; Extension: 9 9/16"	Length: 11 13/16"; Extension: 7 9/16"
polished chrome	808.70.231	808.70.230
matt aluminum	808.70.931	808.70.930
matt nickel	808.70.631	808.70.630
black	808.70.331	808.70.330
white powder-coated	808.70.771	808.70.770

# TAG SYNERGY

See coordinating TAG Decorative Hardware on pages 150–154.



## PANT RACKS

- > Full extension
- > D x H: 14" x 2 5/16"

### Material

Aluminum, anodized

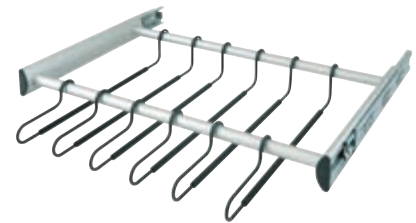

Length	# of hangers	polished chrome	matt aluminum	matt nickel	black
18"	12	805.58.231	805.58.931	805.58.631	805.58.431
24"	18	805.58.233	805.58.933	805.58.633	805.58.433
30"	24	805.58.235	805.58.935	805.58.635	805.58.435

## WIRE PANT HANGERS

- > For pant rack

### Material

Steel



Finish	Item No.
black powder-coated	805.58.332

### Supplied With

18 hangers

## GARMENT CLIP, OPTIONAL

- > Attaches to pant rack hangers for skirts, pants, etc.

### Material

Plastic



Color	Item No.
black	805.58.331

### Note

2 required per hanger.

## SHOE RAILS

- > Requires bracket to the right
- > Ø x L: 3/4" x 36"

### Material

Aluminum, anodized



Finish	Item No.
polished chrome	805.87.210
matt aluminum	805.87.910

## SHOE RAIL BRACKET

- > With 5 mm press-in dowels

### Material

Plastic



Color	Item No.
black	805.87.993

# TAG SYNERGY

See coordinating TAG Decorative Hardware on pages 150–154.



## TILT-OUT HAMPERS

- > Screw mounted to back of door, with removable bags
- > D x H: 13 7/8" x 22"; height is from the top of the frame to the bottom of the bag

### Material

Frame: Plastic/Steel, black; Bag: Nylon, black

Width	# of Bags	Item No.
18"	1 large	547.43.311
24"	2 small	547.43.313
30"	1 large & 1 small	547.43.315

### Supplied With

Frame, Bag/Bags

### Note

Flap Stay Hamper Kit, see page 56.



## PULL-OUT HAMPERS

- > Full extension with removable bags
- > D x H: 14" x 21 1/2"

### Material/Finish

Aluminum, anodized; Bag: Nylon, black

Width	# of Bags	polished chrome	matt aluminum	matt nickel	black
18"	1 large	807.52.231	807.52.931	807.52.631	807.52.331
24"	2 small	807.52.233	807.52.933	807.52.633	807.52.333
30"	1 large & 1 small	807.52.235	807.52.935	807.52.635	807.52.335



## REPLACEMENT BAGS

- > Without handles

### Material/Finish

Nylon, black

W x D x H	Item No.
11 1/4" x 11" x 19 15/16"	547.43.390
15 7/8" x 11" x 19 15/16"	547.43.391



## REPLACEMENT HANDLE

- > Without bags

### Material

Steel/Rubber

Finish	Item No.
black	547.43.399

### Supplied with

2 handles

# TAG ILLUMINATED GLASS SHELF

- > Shelf can be mounted alone or above a drawer to showcase jewelry and other accessories
- > Includes 12 V Loox LED Lighting in your choice of 3000K (warm white) or 4000K (cool white)
- > Mounts quickly and easily with concealed hardware for an attractive installation
- > Shelf frame coordinates with other accessories like ENGAGE, while the glass surface increases visibility
- > Shelf has been tested to hold up to 55 lbs.
- > Optional 1" filler strip available to extend shelf depth



## SHELVES

### Material

Aluminum, Tempered safety glass

Light color	Depth	Width	matt gold	matt nickel	slate
3000K warm white	13 3/4"	18"	807.76.800	807.76.600	807.76.300
		24"	807.76.801	807.76.601	807.76.301
		30"	807.76.802	807.76.602	807.76.302
	20 1/2"	36"	807.76.803	807.76.603	807.76.303
		18"	807.76.820	807.76.620	807.76.320
		24"	807.76.821	807.76.621	807.76.321
4000K cool white	13 3/4"	30"	807.76.822	807.76.622	807.76.322
		36"	807.76.823	807.76.623	807.76.323
		18"	807.76.810	807.76.610	807.76.310
	20 1/2"	24"	807.76.811	807.76.611	807.76.311
30"		807.76.812	807.76.612	807.76.312	
36"		807.76.813	807.76.613	807.76.313	
18"		807.76.830	807.76.630	807.76.330	
20 1/2"	24"	807.76.831	807.76.631	807.76.331	
	30"	807.76.832	807.76.632	807.76.332	
	36"	807.76.833	807.76.633	807.76.333	

### Supplied With

12 V Loox LED Lighting

### Note

Driver must be purchased separately, see next page.

## FILLER STRIPS, OPTIONAL

- > Allows shelf depth to be extended by 1"

### Material

Aluminum

Width	matt gold	matt nickel	slate
18"	807.76.890	807.76.690	807.76.390
24"	807.76.891	807.76.691	807.76.391
30"	807.76.892	807.76.692	807.76.392
36"	807.76.893	807.76.693	807.76.393





# TAG ELITE LIGHTED WARDROBE TUBE KIT

**Note**

\*Indicates finish shown.

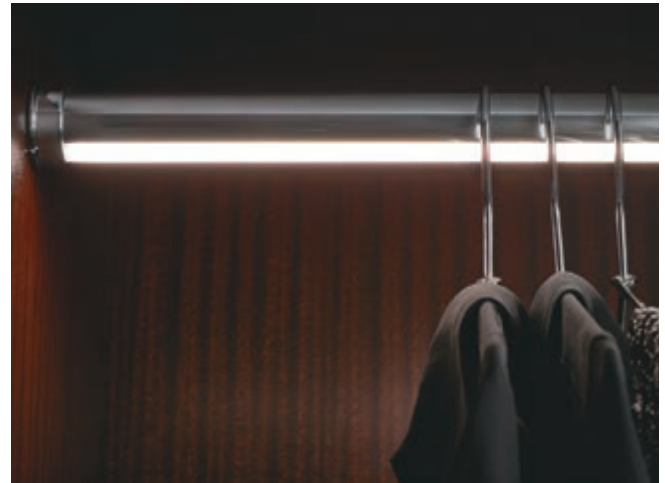

**LOOX 2065**

- > CRI: 90; CRI 90 lights offer more vibrant, true color rendering than lower CRI products and are Title 24 Compliant
- > Choose from warm or cool white
- > Ready to install; Tube is cut 1/4" shorter than nominal size to allow room for end caps and driver cable exit

**Material**

Aluminum

**Light color: 3000K warm white**

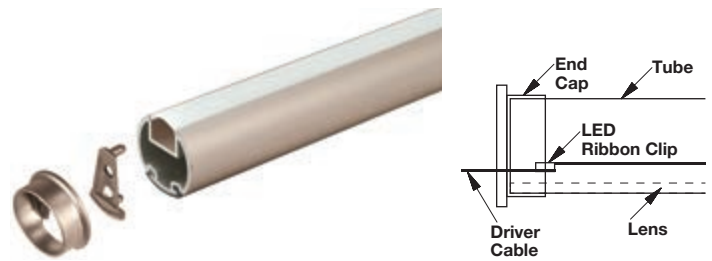

Length	Wattage	Lumen	matt aluminum	polished chrome	matt nickel*	oil-rubbed bronze	matt gold	slate
18"	2.3	213	833.96.020	833.96.028	833.96.036	833.96.044	833.96.052	833.96.060
24"	3.0	284	833.96.021	833.96.029	833.96.037	833.96.045	833.96.053	833.96.061
30"	3.8	355	833.96.022	833.96.030	833.96.038	833.96.046	833.96.054	833.96.062
36"	4.5	426	833.96.023	833.96.031	833.96.039	833.96.047	833.96.055	833.96.063

**Light color: 4000K cool white**

Length	Wattage	Lumen	matt aluminum	polished chrome	matt nickel	oil-rubbed bronze	matt gold	slate
18"	2.3	224	833.96.024	833.96.032	833.96.040	833.96.048	833.96.056	833.96.064
24"	3.0	298	833.96.025	833.96.033	833.96.041	833.96.049	833.96.057	833.96.065
30"	3.8	373	833.96.026	833.96.034	833.96.042	833.96.050	833.96.058	833.96.066
36"	4.5	447	833.96.027	833.96.035	833.96.043	833.96.051	833.96.059	833.96.067

**Supplied With**

Tube, lens, Loox 2065 flexible light strip, 78 3/4" driver cable, 2 end caps

**Note**

Loox lights and drivers are "suitable for use within closet storage spaces". Position cable around and out of tube between lens and end cap or through end cap exit hole.

**LOOX5 12 V DRIVER**

- > Suitable for all of the world's power systems
- > Max. lead length from driver to device: 393 11/16"
- > Drivers must be mounted in well ventilated area
- > With overload protection

**Material/Finish**

Plastic, black



L x W x H	Wattage	Standby power consumption wattage	Input voltage	Output voltage	Output current	Number of slots	Item No.
7 1/2" x 2 3/8" x 5/8"	40	<0.3	100-240 V~; 50-60 Hz	12 V DC	3.33 A	6 for lights, 1 for switch, 1 for power cord	833.95.002

**Supplied With**

Mounting accessories, US power cord

# WARDROBE ACCESSORIES





Häfele's assortment of wardrobe accessories are where functionality and style combine with organization and activity. These are the hooks, hampers, wire baskets, wardrobe lifts, ironing boards and more which allow designers to build out the ideal closet for their customers with an eye for utility. The products and solutions they'll be using and interacting with on a near daily basis are not just essential, they also have to be dependable, good looking and add value to the project.

# WARDROBE LIFTS



## WARDROBE LIFTS

- > Height: 33 1/6"
- > Ø: 7/8" with width adjustment

### Material

Steel/Plastic

Inside closet width	Weight capacity	chrome-plated/black	black powder-coated/black	white powder-coated/white
21 1/4"-26"	26 lbs.	805.31.201	805.31.301	805.31.701
26"-35 1/16"	26 lbs.	805.31.202	805.31.302	805.31.702
35 1/16"-47 5/8"	26 lbs.	805.31.203	805.31.303	805.31.703
35 1/16"-47 5/8"	33 lbs.	805.31.223	805.31.323	805.31.723

## STEEL POLES

- > For optional pole length of the 805.31.xxx wardrobe lifts
- > Ø: 5/8"

### Material

Steel

Length	chrome-plated	white powder-coated
70 7/8"	805.31.295	805.31.795
60"	805.31.296	805.31.796
48"	805.31.297	805.31.797

# WARDROBE LIFTS



## MOTORIZED LIFTS

- > Store clothing in higher spaces when there is limitation in reach and/or strength
- > Motorized 110v electrical plug included but can be hardwired by electrician
- > Wireless remote programs upward and lower range of motion

### Material

Arms and Cross Bars: Steel; Housing: Plastic

Lift	Width	Weight capacity	Vertical lowering range of clothes rail	Tube	Arm	Housing	Item No.
Standard	25"-27"	60 lbs.	30"	chrome	chrome	black	805.32.251
				chrome	black	black	805.32.351
				chrome	chrome	white	805.32.661
	27"-33"	60 lbs.	30"	chrome	chrome	black	805.32.246
				chrome	black	black	805.32.358
				chrome	chrome	white	805.32.766
	34"-48"	60 lbs.	30"	chrome	chrome	black	805.32.254
				chrome	black	black	805.32.354
				chrome	chrome	white	805.32.764
Extended	25"-29"	45 lbs.	50"	chrome	chrome	black	805.32.261
				chrome	black	black	805.32.461
				chrome	chrome	white	805.32.761
	29"-48"	70 lbs.	50"	chrome	chrome	black	805.32.262
				chrome	black	black	805.32.362
				chrome	chrome	white	805.32.763

### Supplied With

Instructions to size the unit to desired width

# CLOSET BASKETS



## WIRE BASKETS

- > Slides included with basket
- > For 18", 24" and 30" interior openings
- > Baskets easily disconnect for portability
- > Optional liners, see page 54

### Material

Steel

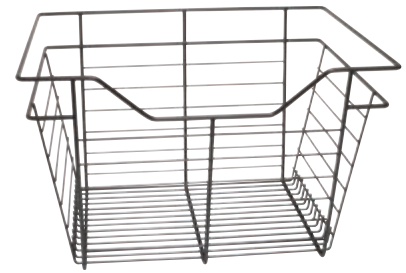

Interior opening	W x D x H	chrome-plated	white powder-coated	matt nickel powder-coated	slate painted	matt gold powder-coated	black powder-coated
18"	17" x 12" x 6"	547.38.212	–	–	–	547.38.812	–
	17" x 12" x 11"	547.38.216	547.38.716	–	–	547.38.816	–
	17" x 12" x 17"	547.38.218	547.38.718	–	–	547.38.818	–
	17" x 14" x 6"	547.38.232	547.38.732	547.38.632	547.38.532	547.38.832	547.38.332
	17" x 14" x 11"	547.38.236	547.38.736	547.38.636	547.38.536	547.38.836	547.38.336
	17" x 14" x 17"	547.38.238	547.38.738	547.38.638	547.38.538	547.38.838	547.38.338
	17" x 16" x 6"	547.38.252	547.38.752	547.38.652	–	547.38.852	547.38.352
	17" x 16" x 11"	547.38.256	547.38.756	547.38.656	–	547.38.856	547.38.356
17" x 16" x 17"	547.38.258	547.38.758	547.38.658	–	547.38.858	547.38.358	
24"	23" x 12" x 6"	547.40.212	547.40.712	–	–	547.40.812	–
	23" x 12" x 11"	547.40.216	547.40.716	–	–	547.40.816	–
	23" x 12" x 17"	547.40.218	547.40.718	–	–	547.40.818	–
	23" x 14" x 6"	547.40.232	547.40.732	547.40.632	547.40.532	547.40.832	547.40.332
	23" x 14" x 11"	547.40.236	547.40.736	547.40.636	547.40.536	547.40.836	547.40.336
	23" x 14" x 17"	547.40.238	547.40.738	547.40.638	547.40.538	547.40.838	547.40.338
	23" x 16" x 6"	547.40.252	547.40.752	547.40.652	–	547.40.852	547.40.352
	23" x 16" x 11"	547.40.256	547.40.756	547.40.656	–	547.40.856	547.40.356
23" x 16" x 17"	547.40.258	547.40.758	547.40.658	–	547.40.858	547.40.358	
30"	29" x 12" x 6"	547.41.212	–	–	–	547.41.812	–
	29" x 12" x 11"	547.41.216	–	–	–	547.41.816	–
	29" x 12" x 17"	547.41.218	–	–	–	547.41.818	–
	29" x 14" x 6"	547.41.232	547.41.732	547.41.632	547.41.532	547.41.832	547.41.332
	29" x 14" x 11"	547.41.236	547.41.736	547.41.636	547.41.536	547.41.836	547.41.336
	29" x 14" x 17"	547.41.238	547.41.738	547.41.638	547.41.538	547.41.838	547.41.338
	29" x 16" x 6"	547.41.252	547.41.752	547.41.652	–	547.41.852	547.41.352
	29" x 16" x 11"	547.41.256	547.41.756	547.41.656	–	547.41.856	547.41.356
	29" x 16" x 17"	547.41.258	547.41.758	547.41.658	–	547.41.858	547.41.358

# CLOSET BASKETS



## CLOTH BASKET LINERS

- > For baskets on page **53**
- > Fabric loops affix with hook and loop fasteners
- > Liners for 17" high baskets have handles



**Material/Color**  
100% Cotton, cream

W x D x H	Item No.
17" x 14" x 6"	547.35.484
17" x 14" x 11"	547.35.485
17" x 14" x 17"	547.35.486
17" x 16" x 6"	547.35.487
17" x 16" x 11"	547.35.488
17" x 16" x 17"	547.35.489
23" x 14" x 6"	547.36.484
23" x 14" x 11"	547.36.485
23" x 14" x 17"	547.36.486
23" x 16" x 6"	547.36.487
23" x 16" x 11"	547.36.488
23" x 16" x 17"	547.36.489
29" x 14" x 6"	547.37.484
29" x 14" x 11"	547.37.485
29" x 14" x 17"	547.37.486
29" x 16" x 6"	547.37.487
29" x 16" x 11"	547.37.488
29" x 16" x 17"	547.37.489

## PLASTIC LINERS

- > For baskets on page **53**
- > Creates a solid bottom



**Material/Finish**  
Plastic, translucent

W x D x H	Item No.
17" x 14" x 6"	547.98.452
17" x 14" x 11" and 17"	547.98.441
17" x 16" x 6"	547.98.472
17" x 16" x 11" and 17"	547.98.461
23" x 14" x 6"	547.98.454
23" x 14" x 11" and 17"	547.98.443
23" x 16" x 6"	547.98.474
23" x 16" x 11" and 17"	547.98.463
29" x 14" x 6"	547.98.456
29" x 14" x 11" and 17"	547.98.445
29" x 16" x 6"	547.98.476
29" x 16" x 11" and 17"	547.98.465

# LAUNDRY HAMPERS



## LAUNDRY HAMPERS, SLANTED

- > Mount by hanging on the back of a tilt-out door with bracket 547.42.XXX series
- > Height: 19 1/2"
- > Optional liners, see page 56

**Material**

Steel

W x D	chrome-plated	white powder-coated	matt nickel powder-coated	slate painted	matt gold powder-coated	black powder-coated
17" x 13 7/16"	547.42.231	547.42.731	547.42.631	547.42.531	547.42.831	547.42.331
17" x 15 7/16"	547.42.241	547.42.741	547.42.641	–	547.42.841	547.42.341
23" x 13 7/16"	547.42.232	547.42.732	547.42.632	547.42.532	547.42.832	547.42.332
23" x 15 7/16"	547.42.242	547.42.742	547.42.642	–	547.42.842	547.42.342

## BRACKETS

- > W x D x H: 8 7/16" x 1" x 2 11/16"

**Material**

Steel



Finish	Item No.
chrome-plated	547.42.990
white, powder-coated	547.42.991
matt nickel, powder-coated	547.42.690
slate, painted	547.42.590
matt gold, powder-coated	547.42.890
black, powder-coated	547.42.390



# LAUNDRY HAMPERS

> For hampers on page 55



## FLAP STAY HAMPER KITS

### Material

Steel

Finish	Item No.
nickel-plated	547.42.993
black	547.42.994

## LAUNDRY HAMPER BAGS

- > Handles attached on both sides
- > Elastic band around the top edge
- > Easy removal
- > Height: 19 1/2"



### Material/Color

100% Cotton, cream

W x D	Item No.
17" x 13 7/16"	547.42.485
17" x 15 7/16"	547.42.486
23" x 13 7/16"	547.42.487
23" x 15 7/16"	547.42.488

## LAUNDRY HAMPER LINERS

- > Creates a smooth, solid surface on the hamper bottom



### Material/Finish

Plastic, translucent

W x D	Item No.
17" x 13 7/16"	547.95.431
17" x 15 7/16"	547.95.433
23" x 13 7/16"	547.95.432
23" x 15 7/16"	547.95.434

# LAUNDRY HAMPER AND SHOE FENCES



## HOOK-ON HAMPER, SLANTED

- > For hanging on mounting bracket to the right
- > Min. inside cabinet width: 13 1/2"
- > W x D: 12 1/2" x 14 3/16"

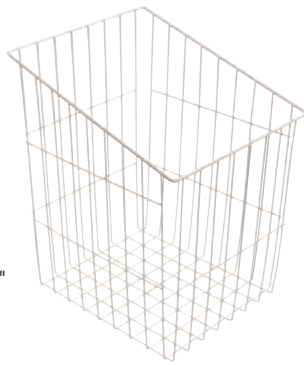

**Material**

Steel wire, epoxy-coated

Color	Item No.
white	540.09.755

## MOUNTING BRACKET

- > For laundry hamper, screw mounted
- > Space between holes: 7 1/2"
- > W x D x H: 8 7/8" x 5/8" x 1"



**Material**

Steel epoxy-coated

Color	Item No.
white	540.06.996

## SHOE FENCES

- > For shelves
- > Attaches to shelf with press-in dowels that fit Ø3/16" drilled holes
- > Dowels are on 1 1/4" center increments



**Material**

Steel

Length	chrome-plated	black powder-coated	matt nickel powder-coated
10 15/16"	547.51.201	547.51.301	547.51.601
17"	547.51.202	547.51.302	547.51.602
23"	547.51.203	547.51.303	547.51.603
29"	547.51.204	547.51.304	547.51.604
35"	547.51.206	547.51.306	547.51.606

# WARDROBE TUBES



## OVAL TUBES WITH SUPPORTS

- > W x H: 9/16" x 1 3/16"
- > Material thickness: Steel: 1.0 mm; Aluminum: 1.3 mm

**Service+**



**Material**

Steel or Aluminum

Length	Steel, chrome-plated	Aluminum, matt aluminum	Aluminum, matt nickel	Aluminum, black
17 3/4"	801.13.245	801.13.385	801.13.685	801.13.365
23 3/4"	801.13.246	801.13.386	801.13.686	801.13.366
29 3/4"	801.13.247	801.13.387	801.13.687	801.13.367
35 3/4"	801.13.248	801.13.388	801.13.688	801.13.368
47 15/16"	801.13.244	801.13.384	801.13.684	801.13.369

## OVAL TUBES

- > W x H: 9/16" x 1 3/16"



**Material**

Steel or Aluminum

Material/Finish	Length	Material Thickness	Item No.
Steel, chrome-plated	8' 2 7/16"	1.0 mm	801.13.201
Steel, chrome-plated	8' 2 7/16"	1.5 mm	801.09.239
Aluminum, matt aluminum	8'	1.3 mm	801.13.391
Aluminum, matt nickel	8'	1.3 mm	801.13.691
Aluminum, black	8'	1.3 mm	801.13.381
Steel, chrome-plated	7' 8"	1.0 mm	801.13.209
Steel, black	7' 8"	1.0 mm	801.13.309

## TUBE SUPPORTS

- > For insertion in 32 mm system holes, with attached dowels and an additional screw hole



**Material**

Zinc die-cast

Finish	Item No.
nickel-plated	803.33.722
chrome	803.33.210
matt aluminum	803.39.300
matt nickel	803.39.600
black	803.64.400

## OVAL CENTER BRACKETS

- > For 9/16" x 1 3/16" tube
- > Surface mount



**Material**

Zinc die-cast

Finish	Item No.
chrome-plated	802.04.208
black	802.04.308

# STORAGE TRAYS

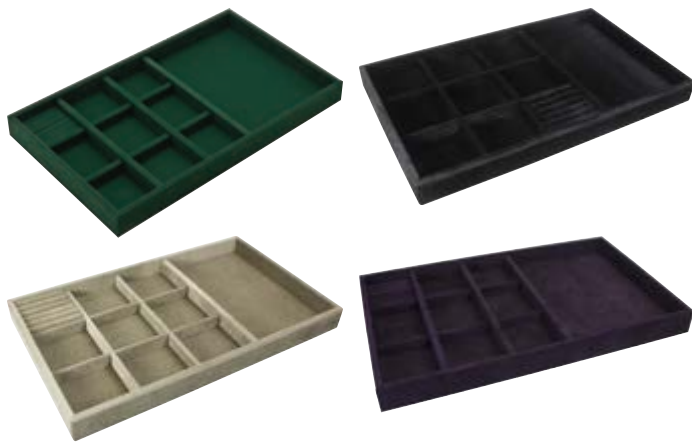

## JEWELRY TRAYS

- > Features one large compartment and nine small compartments, one specially designed for rings
- > W x D x H: 22 15/16" x 14" x 2"

Material	Color	Item No.
Nylon Felt	black	811.03.301
Faux Suede	black	811.03.320
Nylon Felt	gray	811.03.504
Faux Suede	gray	811.03.520
Nylon Felt	maroon	811.03.110
Faux Suede	plum	811.03.120
Nylon Felt	royal blue	811.03.800
Nylon Felt	teal green	811.03.000
Velvet	black	811.03.380
Velvet	silver	811.03.980



## BELT TRAYS

- > Features one long compartment and four smaller compartments
- > 4" depth makes it ideal for storing belts, scarves, underwear, socks, watches and other accessories
- > W x D x H: 23" x 14" x 4"

Material	Color	Item No.
Nylon Felt	gray	811.03.513
Faux Suede	gray	811.03.530

# MATS AND SHELF DIVIDERS



## FLOCK NON-SLIP MATS

- > Luxurious, velvety finish
- > Cut-to-size, non-slip mats prevent sliding or movement of items on shelves, drawers, etc.
- > Noise-dampening and vibration resistant
- > W x L: 23 1/4" x 46 1/16"

**Material**

Face: Flock, Back: Polystyrene

Color	Item No.
anthracite gray	547.94.385
black	547.94.485

**Note**

Sold in sheets.



## FELT CLOTH

- > Self-adhesive
- > For lining drawers in wardrobes and closets
- > Noise-dampening and vibration resistant
- > W x L: 23" x 36"

**Material**

Nylon Felt

Color	Item No.
teal green	811.05.000
maroon	811.05.110
gray	811.05.500
royal blue	811.05.800



## ACRYLIC SHELF DIVIDERS

- > For 3/4" shelves
- > Keeps clothes, purses, towels, etc. organized
- > Clear for excellent visibility
- > Durable, one piece construction
- > Installs quickly and easily by sliding over shelf.

**Material**

Acrylic, clear

Depth	Height	Item No.
12"	5"	771.80.430
14"	5"	771.80.431
12"	8"	771.80.435
14"	8"	771.80.436

# IRONING BOARDS AND ACCESSORIES

HÄFELE IRONFIX®



## SHELF-MOUNTED IRONING BOARDS

- > Rotates 180° degrees with seven pre-set positions
- > The absence of ball bearing slides keeps clothing free of grease or pinch point damage
- > Mounts to a shelf with supplied through bolts
- > Fits into a (W x D) 24" x 14" space
- > W x D x H: 20 1/2" x 13 3/4" x 5 1/8"
- > Extended board length is 37 1/2"



### Material

Steel, epoxy-coated; Cover: Natural White Cotton with gray stripes, foam-backed, heat resistant

Finish	Item No.
white	568.60.781
slate	568.60.581

### Supplied With

Through bolts

## WALL-MOUNTED IRONING BOARD

- > W x D x H: 12 7/8" x 4 3/4" x 20 5/8"



### Material

Steel, epoxy-coated; Cover: Natural White Cotton with gray stripes, foam-backed, heat resistant

Finish	Item No.
white	568.66.700

### Supplied With

Installation hardware

### Note

Dimensions are in closed position.

## BUILT-IN IRONING BOARD

- > Cabinet inside clear width: 14 1/4"-19 11/16"
- > Cabinet inside clear depth: 19 11/16"



### Material

Steel, epoxy-coated  
Cover: Natural White Cotton with gray stripes, foam-backed, heat resistant

Finish	Item No.
white	568.60.710

### Supplied With

Installation hardware  
Runners

## WALL COVER, OPTIONAL

- > For use with 568.66.700
- > W x D x H: 14 3/8" x 5 1/2" x 23 7/16"



### Material

Polystyrene

Finish	Item No.
white	568.66.790

# IRONING BOARDS AND ACCESSORIES



## ROTATING VERTICAL MOUNT IRONING BOARD

- > Easy opening and release
- > Strong and sturdy
- > Ideal for closets, laundry rooms and more
- > Minimum inside depth: 12 3/16"
- > Minimum inside width: 13 3/8"

**Material**

Steel

	<b>Item No.</b>
	568.67.900

**Supplied With**

Installation hardware and cover



## REPLACEMENT COVER

- > Heat resistant

**Material**

Cotton

	<b>Item No.</b>
	568.67.900



## IRON HOLDER

- > Stores iron and cord
- > Mounts quickly and easily
- > Great accompaniment for Ironfix ironing boards

**Material**

Steel

	<b>Item No.</b>
<b>Finish</b>	520.20.280
polished chrome	

# ELECTRONIC LOCK



## STEALTHLOCK

- > Digital control of cabinet door and drawers
- > Operates in passage or cycle modes, and releases with a RF controlled key pad
- > One key pad activates an unlimited number of locks
- > W x D x H: 7/16" x 6 3/4" x 2 1/2"

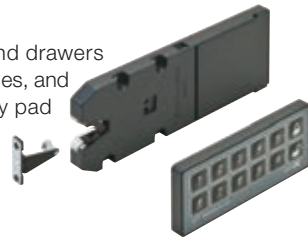

**Material/Finish**  
Steel/Plastic, black

Description	Item No.
Set	237.56.350
Lock only	237.56.352

**Set Supplied With** Lock, latch and keypad

**Lock Supplied With** Lock and latch

**Note**

Powered by 4 AAA batteries (not supplied) or Loox power supply. Programming cabinet lock 237.56.352 with dedicated key pad 237.56.171 will link or "marry" key pad and lock together for dedicated use.



## KEY PAD MOUNTING PLATE

- > W x D x H: 4 5/16" x 3/8" x 1 3/4"

**Material**  
Aluminum

Finish	Item No.
gray	237.56.994



## DRYWALL MOUNTING PLATE

- > Allows mounting to a wall or any flat surface

**Material**  
Aluminum

Finish	Item No.
satin nickel	237.56.974

## STEALTHLOCK LOOX3 POWER CORDS

**Material/Color**  
Plastic, black/red/gray



Length	Item No.
60"	237.56.380
120"	237.56.381

**Note** Power up to 10 Stealthlocks via LoOX3 power supply.



## POWER EXTENSION CORDS

**Material/Color**  
Plastic, black/red

Length	Item No.
36"	237.56.996
60"	237.56.997
120"	237.56.998



## BATTERY POWER CORD

- > For 9V Battery power back up

**Material/Color**  
Plastic, black/red

Length	Item No.
120"	237.56.999



## POWER SUPPLY

- > Voltage: 7.5VDC
- > Amperage: 1.5A
- > For use with StealthLock
- > Powered solution for StealthLock locking system

**Material/Color**  
Plastic, black

Length	Item No.
66"	237.56.995

**Note**

Connects receiver latch to 120 VAC power. One power supply can support/power 10 locks.



## ADDITIONAL DOOR STRIKE PLATE

**Material**  
Steel

Color	Item No.
black	237.56.988



## ADDITIONAL INSTALLATION TOOL

**Material**  
Plastic

Color	Item No.
red	237.56.992



# EFL 51 FURNITURE LOCK

> Intelligent locker lock for indoor use in wardrobes, lockers and cabinets for wood, glass or sliding doors

**Functionality:**

**Standard mode**

One or several (optional) user keys have a fixed allocation to one or several (optional) lockers for locking and unlocking. The lock remains open for 3 seconds after opening, and locks again automatically.

**Wellness mode (free choice of locker)**

Any user card can lock an open locker. The user card is assigned to the selected locker, only this user card can unlock the locker. When the locker is unlocked, the assignment is deleted.

**Toggle mode (deadbolt lock function)**

When an authorized transponder is held in front of the device, the lock unlocks and remains unlocked. When the authorized transponder is presented again, the lock is locked.

**Technical Data**

Technology: Mifare Classic  
 Degree of protection: IP20  
 Battery: CR 123 3V  
 Battery service life: Approx. 20,000 locking and unlocking processes  
 Number of possible keys: 49  
 Operating temperature: 5 °C – +35 °C  
 Reading range: Card: max. 20 mm (25/32"); Tag: max. 10 mm (3/8")

**Note**

Particularly suitable for furniture with soft and self-closing mechanisms. For drawers and hinged doors with push-to-open function, the locking component must also be installed. If the battery voltage is too low, the lock no longer locks and a 15 second continuous tone is emitted. In order to avoid interference between locks, a minimum distance of 10 cm (3 15/16") must be maintained between installed locks and also during storage. If the distance is less than this minimum, continuous communication will take place between the locks, which will drain the battery. To avoid unnecessary battery draining, do not insert the battery until start-up.

**EFL 51**

> Powered by Loox 12 V driver

**Material**

Plastic



Finish	Item No.
black	231.07.401

**Supplied with**

Installation instructions

**Note**

Please order the locking component and the batteries separately. Modes which differ from the standard must be ordered separately (Wellness/Toggle programming cards). Loox driver, see page 48.

**LEADS FOR EFL 51**

**Material**

Plastic



Length	Item No.
19 11/16"	833.72.880
39 3/8"	833.72.881
78 3/4"	833.72.882

**LOCKING COMPONENT**

- > The striking plate has a pre-determined breaking point which breaks at about 77 lbs.
- > The locking bolt is floating, which can compensate for tolerances of +/- 3 mm
- > Suitable for constructions with soft and self-closing mechanisms



**Material**

Plastic

Finish	Item No.
black	231.07.410

# SAFE



## DIGITAL KEYPAD SAFE

- > Perfect for the closet
- > Designed to fit within a standard 18" wide x 14" deep opening
- > Electronic keypad accepts a customized 3-6 digit access code and features a master code option
- > Emergency keys (2) are included in case battery power is lost or the access code is forgotten
- > Includes mounting holes so the safe can be anchored securely to a wall or shelf
- > Fixed shelf inside for optimal storage
- > Strong, durable steel construction
- > Side thickness: 1/16"; Door thickness: 3/16"
- > Weight: 31 lbs.
- > Dimensions (W x D x H): \*Outside: 16" x 13" x 11 7/8"  
Inside: 15 1/2" x 10" x 11 1/2"

### Material

Steel, powder-coated

Finish	Item No.
black	836.21.351

### Note

\*Outside depth includes keypad.  
Requires 4 AA batteries (not supplied).

# POINTS SAFE

- > Solid single steel wall body
- > Double steel wall door
- > Anti-drill plate in door frame
- > Electronic combination lock (German made)
- > Operated with 4 AA batteries
- > Self-programmable master and user codes
- > Two drillings on the back wall and on the bottom for mounting

**Supplied With**  
Mounting Hardware



## COMPACT

- > Administrator code, User code, Emergency key
- > Exterior H x W x D: 7 1/16" x 11" x 8 7/16"
- > Interior H x W x D: 6 13/16" x 10 3/4" x 5 9/16"

**Material**  
Steel

Finish	Item No.
black/gray	836.50.310



## STANDARD

- > Administrator code, User code, Emergency key
- > Exterior H x W x D: 10 1/16" x 13 3/4" x 12 3/8"
- > Interior H x W x D: 9 3/4" x 13 1/2" x 9 1/2"

**Material**  
Steel

Finish	Item No.
black/gray	836.50.311



## STANDARD

- > With fingerprint reader
- > Administrator code, User code, 5 Fingerprint codes, Emergency key
- > Exterior H x W x D: 10 1/16" x 13 3/4" x 12 3/8"
- > Interior H x W x D: 9 3/4" x 13 1/2" x 9 1/2"

**Material**  
Steel

Finish	Item No.
black/gray	836.50.300

# COLOMA

- > For contemporary, sleek, European designed closets
- > Simple installation
- > Designs can incorporate drawers and wood or glass shelves



## SLOTTED PROFILES

- > For 3/4" back panels
- > Three-way adjustable with the use of wall fasteners and adjustable legs
- > Slots are 5/8" apart
- > D X H: 1 3/16" x 9' 2 1/4"

### Material

Aluminum

Mounting	Item No.
Between panels	793.00.113
End mounting	793.00.114

## WALL FASTENER, SINGLE SIDED

- > Designed specifically for use with slotted profiles that are mounted in corners or ends
- > Unhanded
- > Attaches the slotted profile to the wall
- > With slotted hole for horizontal adjustment
- > Mount a maximum of 24" apart
- > W x D X H: 2 3/8" x 3/4" x 1 1/8"



### Material

Steel

Finish	Item No.
zinc-plated	793.00.001

### Note

Works with all slotted profiles.

## WALL FASTENER, DOUBLE SIDED

- > Attaches the slotted profile to the wall
- > With slotted hole for horizontal adjustment
- > Mount a maximum of 24" apart
- > Cannot be mounted in the same location as a shelf or drawer bracket
- > W x D X H: 2 15/16" x 3/4" x 1 1/2"



### Material

Aluminum

Finish	Item No.
zinc-plated	793.00.002

### Note

Works with all slotted profiles.

# COLOMA

- > For contemporary, sleek, European designed closets
- > Simple installation
- > Designs can incorporate drawers and wood or glass shelves



## COVER BRUSH



- > Slides into slotted profile to conceal slots
- > Length: 9' 2 1/4"

Color	Item No.
gray	793.00.005

**Note**  
Works with all slotted profiles.

## PANEL CLIP

- > Attaches panels to slotted profiles
- > Clips allow back panel to be snapped into place by securing between profiles
- > Quick mount with breakaway tabs for alignment
- > Panels must be 3/4" thick
- > W x D X H: 1 3/8" x 1/2" x 4"



**Material**  
PVC

Color	Item No.
gray	793.00.004

**Note**  
Works with all slotted profiles.  
8 clips are required per panel.

## ADJUSTABLE LEG

- > Mounts to the bottom of the slotted profile
- > Pin holds profile in place
- > W x D: 1 5/8" x 1 5/8"
- > Height adjustable from: 7/8"-1 7/16"

### FOR SLOTTED PROFILE 793.00.113



**Material**  
Steel

Finish	Item No.
zinc-plated	793.00.003

### FOR SLOTTED PROFILE 793.00.114



**Material/Finish**  
Steel, zinc-plated

Orientation	Item No.
right	793.00.129
left	793.00.130

# COLOMA

- > Brackets mount to slotted profile
- > Gives cabinets, shelves and drawers a floating appearance



## SHELF BRACKET SETS

- > Shelves can be independently adjusted
- > Weight capacity: 110 lbs.

### Material/Finish

Steel, powder-coated, silver

Depth	Shelf thickness	Item No.
12"	1 1/8"	793.00.401
14"	1 1/8"	793.00.413
18"	1 1/8"	793.00.425
22"	1 1/8"	793.00.437
12"	1 1/2"	793.00.404
14"	1 1/2"	793.00.416
18"	1 1/2"	793.00.428
22"	1 1/2"	793.00.440

## BOTTOM SHELF BRACKET SETS

- > Specially designed to utilize space for shelves at the bottom of the closet
- > Shelves can be independently adjusted
- > Weight capacity: 110 lbs.

### Material/Finish

Steel, powder-coated, silver

Depth	Shelf thickness	Item No.
12"	1 1/8"	793.00.400
14"	1 1/8"	793.00.412
18"	1 1/8"	793.00.424
22"	1 1/8"	793.00.436
12"	1 1/2"	793.00.403
14"	1 1/2"	793.00.415
18"	1 1/2"	793.00.427
22"	1 1/2"	793.00.439

### Note

Toe kicks should be installed under shelves for additional support.

# COLOMA

- > Brackets mount to slotted profile
- > Gives cabinets, shelves and drawers a floating appearance



## CONCEALED CABINET BRACKET SETS

- > Attaches to the back of cabinet and is not visible
- > Weight capacity: 110 lbs.
- > Height: 4 3/4"

**Material**

Steel, powder-coated



Finish	Item No.
silver	793.00.448

**Note**

Use two sets to double the weight capacity. Standard and concealed cabinet brackets cannot be combined on a row of drawers.

## CABINET BRACKET SETS

- > Specially designed to hold floating cabinets using 1 1/8" or 1 1/2" thick material
- > Weight capacity: 132 lbs.

**Material/Finish**

Steel, powder-coated, silver

Depth	Shelf thickness	Item No.
12"	1 1/8"	793.00.402
14"	1 1/8"	793.00.414
18"	1 1/8"	793.00.426
22"	1 1/8"	793.00.438
12"	1 1/2"	793.00.405
14"	1 1/2"	793.00.417
18"	1 1/2"	793.00.429
22"	1 1/2"	793.00.441

## ANGLED SHELF BRACKET SETS

- > For shoe shelves
- > Weight capacity: 110 lbs.
- > Depth: 14"

**Material**

Steel, powder-coated, silver

For Shelf Thickness	Item No.
1 1/8"	793.00.127
1 1/2"	793.00.125

## GLASS SHELF BRACKET SETS

- > For glass thickness: 3/16"-3/8"
- > Weight capacity: 100 lbs.
- > H x D: 3 3/16" x 5"

**Material**

Steel, powder-coated



Finish	Item No.
silver	793.00.450

# WALL BEDS







Adding Häfele wall beds into your project is the ultimate in room transformation. Whether it be a guest room, office or exercise area, all can quickly transform, providing the flexibility you need to best utilize available space. Our bed hardware comes with unique design and adjustability features which designers, installers and owners each appreciate and love.

# WALL BEDS



## HÄFELE WALL BEDS

- > Fitting for vertical folding beds
- > Integrated feet extend as bed is opened and retract when closed
- > For use with light foam mattresses, 6"-10" thick, without box springs
- > Casework to be constructed by end user
- > Inside depth of case: 18 1/2"-23 5/8"

### Material/Finish

Steel; Frame: black epoxy; Folding feet: silver epoxy  
Slats: Laminated Beech, natural lacquered

Size	Item No.
Single/Twin	271.92.016
Double/Full	271.92.025
Queen	271.92.132

### Supplied With

- Complete frame
- Mounting brackets and hardware
- 2 Safety brackets
- 3 Bed straps
- Mattress retainer
- Drilling template

### Note

Installation and casework construction requires a professional skill level. Casework should be high quality material with a minimum thickness of 3/4". Cabinets must be secured against tipping; 2 safety brackets are supplied. Wall bed will not operate properly unless weight ranges are adhered to. Additional information regarding cabinet and mattress specifications can be found at [hafele.com](http://hafele.com).

## GENERAL WEIGHT PARAMETERS

	Front panel weight (approx.)	Mattress weight	Combined lifting capacity
Single/Twin	60 lbs.	35-48 lbs.	95-108 lbs.
Double/Full	84 lbs.	50-68 lbs.	134-152 lbs.
Queen	100 lbs.	60-80 lbs.	160-180 lbs.

### Note

Wall bed will not operate properly unless the above weight ranges are adhered to.

## SAFETY BRACKET

- > Additional brackets to secure bed to wall

### Material

Steel



Color	Item No.
black	271.98.100

# WALL BED KIT

- > For vertical folding beds used in lofts, guest rooms, home offices, etc.
- > Fits mattresses up to 10" thick
- > Optional comfort slat system, cover caps and extending leg
- > Quick and simple assembly

**Note**

Successful and safe installation of hardware and construction of casework requires a professional skill level. Casework to be constructed of high quality material with a minimum thickness of 19 mm (3/4"). Cabinet must be safely secured against tipping, three safety brackets are included.



## INSTALLATION



Turn the screw counter clockwise = Door will go down to loosen

Turn the screw clockwise to tighten = Door will go up

**Note**

That ends are rounded so that doors can slide left to right for a better adjustment.



Door brackets attach front panels to support bars for quick and simple installation. Door brackets include height adjustment screws that allow for easy adjustment of front panels.

## INSIDE MEASUREMENTS

Size	Width	Depth	Height
Twin	44 5/16"	14 1/2"	79 15/16"
Double/Full	59 5/16"	14 1/2"	79 15/16"
Queen	65 5/16"	14 1/2"	84 15/16"

## OUTSIDE MEASUREMENTS

Size	Width	Depth	Height
Twin	45 13/16"	16"	81 7/16"
Double/Full	60 13/16"	16"	81 7/16"
Queen	66 13/16"	16"	86 7/16"

## CABINET DIMENSIONS

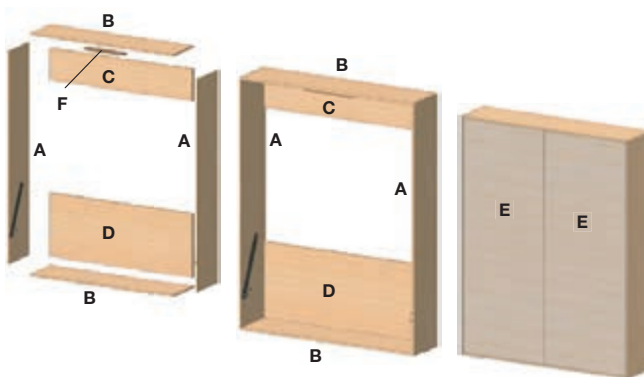

## TWIN

	Qty.	Width	Length
A	2	16"	81 7/16"
B	2	16"	44 5/16"
C	1	13"	44 5/16"
D	1	26"	44 5/16"
E	1	43 7/8"	79 1/4"
F	1	2 15/16"	17 15/16"

## DOUBLE/FULL

	Qty.	Width	Length
A	2	16"	81 7/16"
B	2	16"	59 5/16"
C	1	13"	59 5/16"
D	1	26"	59 5/16"
E	2	29 7/16"	79 1/4"
F	1	2 15/16"	17 15/16"

## QUEEN

	Qty.	Width	Length
A	2	16"	86 7/16"
B	2	16"	65 5/16"
C	1	13"	65 5/16"
D	1	26"	65 5/16"
E	2	32 1/2"	84 5/16"
F	1	2 15/16"	17 15/16"

**Note**

Suggested dimensions for 3/4" material.

# WALL BED

## WALL BED KITS

### Material/Finish

Steel, black



Size	Pistons	Item No.
Twin	1200N	271.92.201
Double/Full	1600N	271.92.202
Queen	1900N	271.92.200

### Supplied With

Frame, Safety brackets, 2 Gas pistons, Mounting hardware



## GENERAL WEIGHT PARAMETERS

Size	Front panel weight	Mattress weight	Comfort slat system or plywood sheet	Combined lifting capacity
Twin	60 lbs.	30–50 lbs.	20–25 lbs.	110–135 lbs.
Double/Full	80 lbs.	55–80 lbs.	30–35 lbs.	165–195 lbs.
Queen	100 lbs.	65–85 lbs.	30–35 lbs.	195–220 lbs.

### Note

Wall bed will not operate properly unless the above weight ranges are adhered to.

## GAS PISTONS

> Available if lighter or heavier mattress or front panels are being used

Pistons strength (N)	Average front panel	Mattress	Comfort slat kit or plywood sheet	Combined lifting capacity	Item No.
1200	65 lbs.	30–45 lbs.	20–25 lbs.	110–130 lbs.	271.92.265
1300	70 lbs.	35–50 lbs.	20–25 lbs.	125–140 lbs.	271.92.266
1400	75 lbs.	40–55 lbs.	20–25 lbs.	135–150 lbs.	271.92.267
1500	75 lbs.	55–70 lbs.	30–35 lbs.	145–160 lbs.	271.92.268
1600	80 lbs.	65–80 lbs.	30–35 lbs.	155–170 lbs.	271.92.269
1700	85 lbs.	55–75 lbs.	30–35 lbs.	165–185 lbs.	271.92.270
1800	95 lbs.	60–80 lbs.	30–35 lbs.	180–195 lbs.	271.92.271
1900	100 lbs.	65–85 lbs.	30–35 lbs.	195–220 lbs.	271.92.272
2000	100 lbs.	75–95 lbs.	30–35 lbs.	205–230 lbs.	271.92.273
2100	100 lbs.	85–105 lbs.	30–35 lbs.	215–235 lbs.	271.92.274
2200	100 lbs.	95–115 lbs.	30–35 lbs.	225–250 lbs.	271.92.275

## COMFORT SLAT SYSTEMS

- > Easy to install
- > Increases comfort
- > Flexible curved slats



### Material/Finish

Steel/Plywood, black

Size	Item No.
Twin	271.92.261
Double/Full	271.92.262
Queen	271.92.260

## COVER CAP

- > Conceals mounting plates and pistons
- > Two-piece cap is quick and easy to install

### Material

Steel

Finish	Item No.
black	271.92.250

# WALL BED

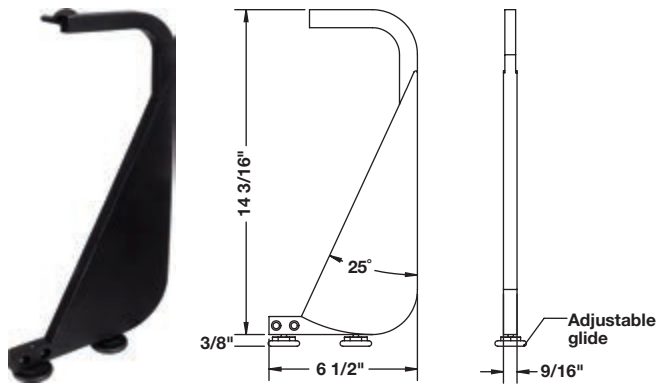

## EXTENDED LEG FOR WALL BED

- > For wall beds that have bases or toe kicks
- > Adjustable glide provides 1/2" height adjustment
- > Allows for mattresses up to 12" thick
- > Height: 14 3/16"

### Material

Steel

Finish	Item No.
black	271.92.290

### Note

When using the extended leg, refer to the cabinet dimensions below.

## CABINET DIMENSIONS

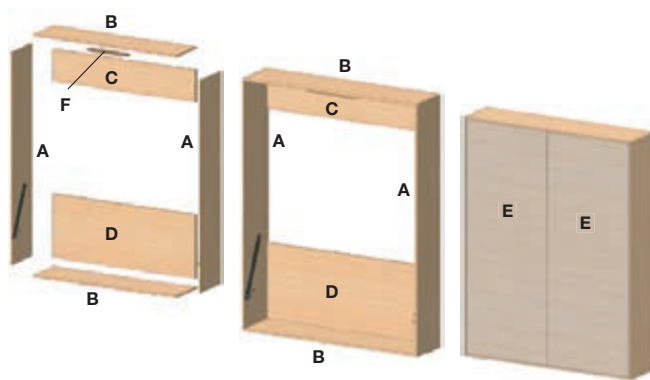

## INSIDE MEASUREMENTS

Size	Width	Depth	Height
Twin	44 5/16"	16 7/8"	82 5/16"
Double/Full	59 5/16"	16 7/8"	82 5/16"
Queen	65 5/16"	16 7/8"	87 3/8"

## OUTSIDE MEASUREMENTS

Size	Width	Depth	Height
Twin	45 13/16"	18 3/8"	83 13/16"
Double/Full	60 13/16"	18 3/8"	83 13/16"
Queen	66 13/16"	18 3/8"	88 7/8"

## TWIN CABINET DIMENSIONS

	Qty.	Width	Length
A	2	18 3/8"	83 13/16"
B	2	18 3/8"	44 5/16"
C	1	13"	44 5/16"
D	1	26"	44 5/16"
E	1	43 7/8"	81 5/8"
F	1	2 15/16"	17 15/16"

## FULL/DOUBLE CABINET DIMENSIONS

	Qty.	Width	Length
A	2	18 3/8"	83 13/16"
B	2	18 3/8"	65 5/16"
C	1	13"	65 5/16"
D	1	26"	65 5/16"
E	2	32 1/2"	81 5/8"
F	1	2 15/16"	17 15/16"

## QUEEN CABINET DIMENSIONS

	Qty.	Width	Length
A	2	18 3/8"	88 7/8"
B	2	18 3/8"	65 5/16"
C	1	13"	65 5/16"
D	1	26"	65 5/16"
E	2	32 1/2"	86 11/16"
F	1	2 15/16"	17 15/16"

# GARAGE ORGANIZATION





We call it garage organization, but it's really so much more. These are the products which you'll use in your most functional areas – the garage, craft and scrapbooking room, home gym and more – to ensure everything you need for that particular activity has a dedicated place. Featured solutions include wall organization such as Omni Track® and HandiWALL® – each available as kits or completely customized – to products like the Syzzor Loft and Super Pro which tackle overhead storage with ease.

# SYZZOR LOFT

- > Designed to eliminate the need for a ladder
- > Raise/lower using a hand-crank or drill
- > Installed dimensions: D x W: 4' x 7'
- > Retraction: 6'
- > Weight capacity: 800 lbs.
- > No wires or power cables
- > Syzzor for stability
- > Cable for support



**Material**

Steel, powder-coated

**Finish**

white

**Item No.**

792.30.000

**Supplied With**

Hand-crank  
Mounting hardware

**Note**

Totes are not provided and must be purchased separately.

Lowered position (front view)

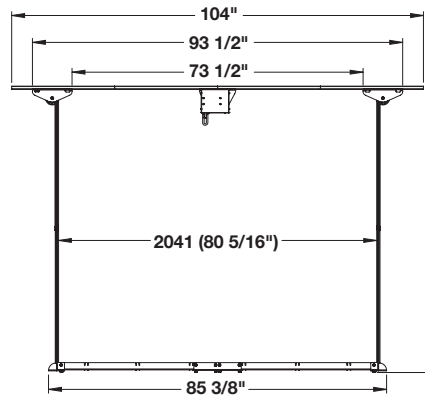

Lowered position (side view)

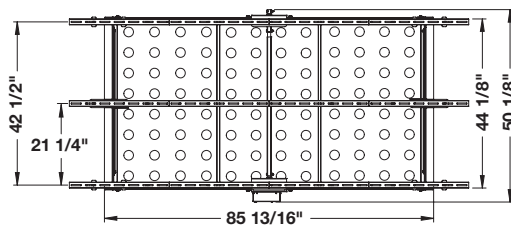
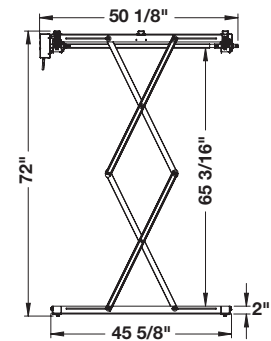

Raised position (front view)

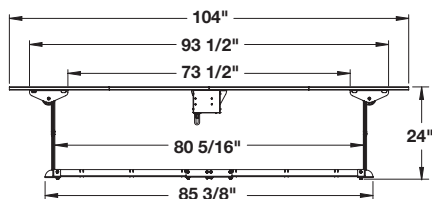

Raised position (side view)

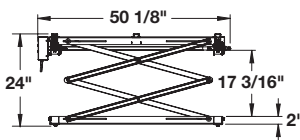



# SUPER PRO

- > Designed for seamless installation
- > Down-rods can be installed anywhere on the perimeter of the frame, allowing for versatility in the placement and configuration of each unit
- > Installed dimensions D x W: 4' x 7'
- > Weight capacity: 800 lbs.

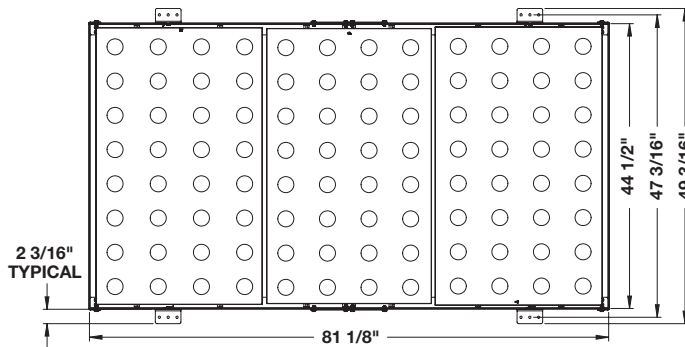

**Front view**

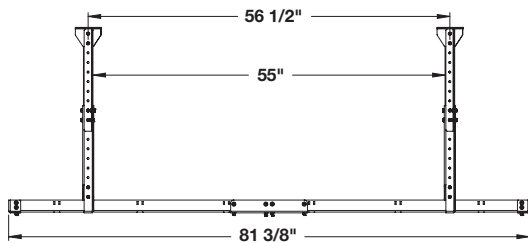

**Side view**

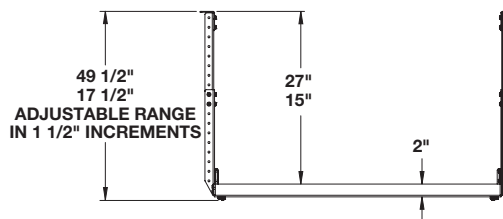

**Material**

Steel, powder-coated

**Finish**

white

**Item No.**

792.30.010

**Supplied With**

Mounting hardware

**Note**

Totes are not provided and must be purchased separately.

# OMNI TRACK<sup>®</sup> READY PACK KITS

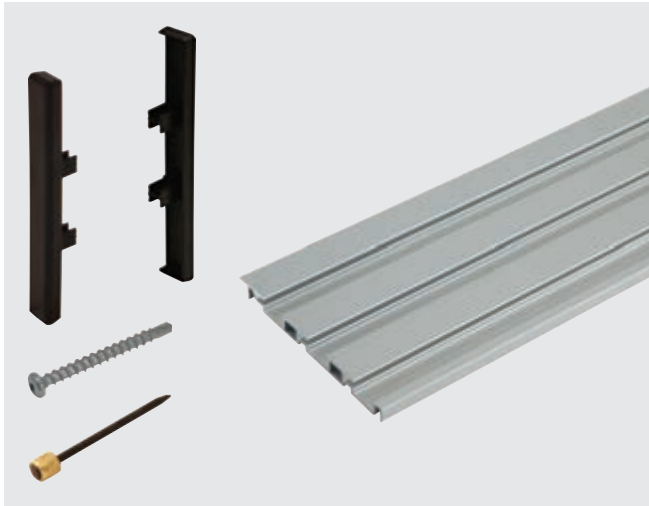

## READY PACK TRACK KIT - 97"

	Packing	Item No.
	1 set	792.00.002

### Consisting of:

	Qty.	Item No.
Wall Track 97"	2 pcs.	792.00.000
Plastic Edge Profile	8 pcs.	792.00.320
Truss Head Screw #10 X 2 1/2"	100 pcs.	792.01.993
Installation Nail	1 pkg. (50 pcs.)	792.01.998

### Note

Accessories sold separately, not included in track kits, see page 82.

## READY PACK TRACK KIT - 48"

	Packing	Item No.
	1 set	792.00.001

### Consisting of:

	Qty.	Item No.
Wall Track 48"	4 pcs.	792.00.000
Plastic Edge Profile	8 pcs.	792.00.320
Truss Head Screw #10 X 2 1/2"	100 pcs.	792.01.993
Installation Nail	1 pkg. (50 pcs.)	792.01.998
Track Joiner	4 pcs.	792.00.310

### Note

Accessories sold separately, not included in track kits, see page 82.

# OMNI TRACK® READY PACK KITS

## READY PACK LAWN/GARDEN KIT

	Packing	Item No.
	1 set	792.02.241
<b>Consisting of:</b>		
	Qty.	Item No.
<b>A</b>	1 pc.	792.02.202
<b>B</b>	2 pcs.	792.02.203
<b>F</b>	4 pcs.	792.02.200
<b>N</b>	2 pcs.	792.02.255
<b>Q</b>	1 pc.	792.02.382
	10 pcs.	792.02.349
	2 pcs.	792.02.399

**Note**

Track not included, see track kits page 81.

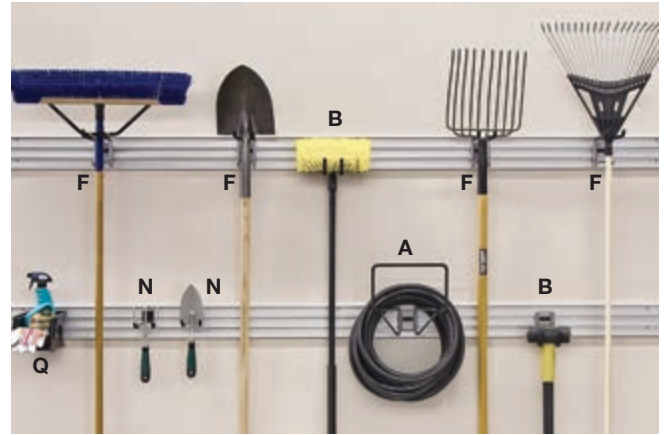

## READY PACK SPORTS KIT

	Packing	Item No.
	1 set	792.02.000
<b>Consisting of:</b>		
	Qty.	Item No.
<b>B</b>	2 pcs.	792.02.203
<b>C</b>	2 pcs.	792.02.004
<b>D</b>	1 pc.	792.02.005
<b>G</b>	2 pcs.	792.02.201
<b>Q</b>	2 pcs.	792.02.382
	10 pcs.	792.02.349

**Note**

Track not included, see track kits page 81.

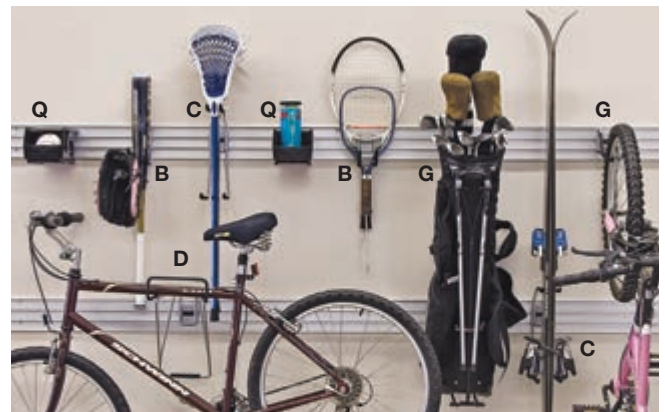

## READY PACK WORK/CRAFT BENCH KIT

	Packing	Item No.
	1 set	792.02.240
<b>Consisting of:</b>		
	Qty.	Item No.
<b>H</b>	3 pcs.	792.02.250
<b>I</b>	3 pcs.	792.02.251
<b>J</b>	3 pcs.	792.02.252
<b>L</b>	3 pcs.	792.02.253
<b>M</b>	1 set	792.02.254
<b>N</b>	2 pcs.	792.02.255
<b>O</b>	2 pcs.	792.02.380
<b>P</b>	2 pcs.	792.02.381
<b>Q</b>	2 pcs.	792.02.382
	17 pcs.	792.02.399
	2 pcs.	-

**Note**

Track not included, see track kits page 81.

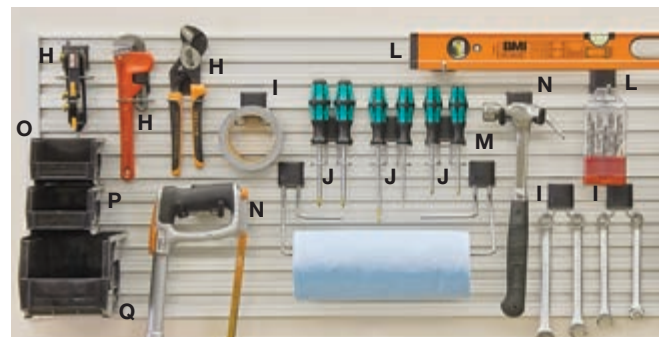
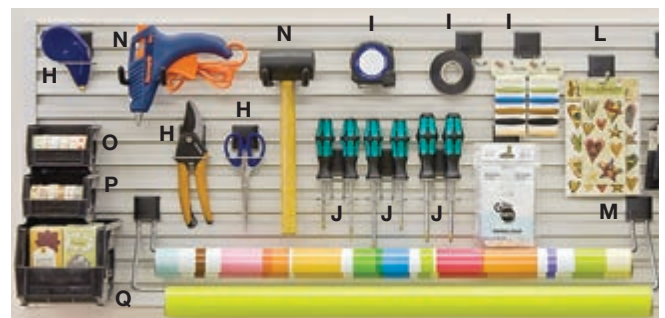

# OMNI TRACK®



## WALL TRACK

- > For use with hooks, bins and baskets
- > Tracks can be seamlessly overlapped to create a panel
- > L x H x D: 97" x 4 3/4" x 1/2"



**Material**

Aluminum

Finish	Item No.
matt aluminum	792.00.000

## END CAPS

- > Covers a single wall track end for a finished look
- > Includes right and left profile
- > W x H: 1/2" x 5"



**Material**

Plastic

Color	Item No.
black	792.00.320

## EDGE PROFILE

- > Covers wall track ends for a finished look
- > Attaches with mounting tape 792.01.994
- > L x H x D: 96" x 15/16" x 1/2"



**Material**

Aluminum

Finish	Item No.
matt aluminum	792.01.000

## SHELF STIFFENER

- > Adds strength and protection to panel edges
- > Taps on with a rubber mallet
- > L x H x D: 96" x 13/16" x 15/16"



**Material**

Aluminum

Finish	Item No.
matt aluminum	792.01.030

# OMNI TRACK®

> Hooks are used with wall track 792.00.000

**Note**

Cover cap 792.02.349 is required.



## 16" UTILITY HOOK

- > Horizontal storage for bicycles; use two hooks for long items
- > L x W x H: 15 7/8" x 8 1/4" x 16 3/16"
- > Weight capacity: 50 lbs.

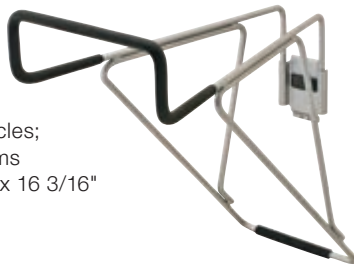

**Material**

Steel/Rubber-Coated

Finish/Color	Item No.
matt aluminum/black	792.02.005

## HOSE HOOK

- > Stores garden hoses, ropes and extension cords
- > L x W x H: 7 7/16" x 10 13/16" x 10 13/16"
- > Weight capacity: 50 lbs.



**Material**

Steel/Rubber-Coated

Finish/Color	Item No.
matt aluminum/black	792.02.202

## UTILITY HOOK

- > For general use
- > L x W x H: 5 13/16" x 2 13/16" x 5 1/16"
- > Weight capacity: 25 lbs.



**Material**

Steel/Rubber-Coated

Finish/Color	Item No.
matt aluminum/black	792.02.203

## GARDEN TOOL HOOK

- > Hold multiple long handled garden tools
- > L x W x H: 9 1/4" x 2 5/16" x 4 5/16"
- > Weight capacity: 25 lbs.



**Material**

Steel/Rubber-Coated

Finish/Color	Item No.
matt aluminum/black	792.02.200

## 14" UTILITY HOOK

- > Horizontal storage for bicycles, garden tools or beach chairs
- > L x W x H: 14 3/8" x 2 13/16" x 5 1/4"
- > Weight capacity: 50 lbs.



**Material**

Steel/Rubber-Coated

Finish/Color	Item No.
matt aluminum/black	792.02.070

## COVER CAP

- > W x D x H: 1 1/2" x 1/2" x 11/16"



**Material**

Plastic

Color	Item No.
black	792.02.349

# OMNI TRACK®

> Hooks are used with wall track 792.00.000

**Note**

Cover cap 792.02.349 is required.

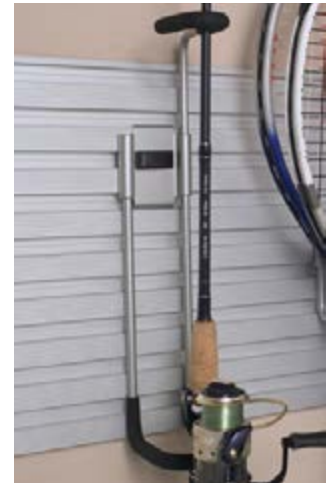

## ACTIVITY HOOK

- > Stores skis, snowboards, baseball bats, lacrosse sticks and rackets
- > L x W x H: 9 1/2" x 3" x 12 11/16"
- > Weight capacity: 25 lbs.



**Material**

Steel/Rubber-Coated

Finish/Color	Item No.
matt aluminum/black	792.02.004

## FISHING ROD HOOK

- > Vertically stores one fishing rod
- > L x W x H: 5" x 2 13/16" x 15 1/4"
- > Weight capacity: 25 lbs.



**Material**

Steel/Rubber-Coated

Finish/Color	Item No.
matt aluminum/black	792.02.006

## BIKE HOOK

- > Vertical storage of one bicycle, golf bags or leaf blowers
- > L x W x H: 5 9/16" x 3 1/2" x 4 15/16"
- > Weight capacity: 40 lbs.



**Material**

Steel/Rubber-Coated

Finish/Color	Item No.
matt aluminum/black	792.02.201

## SMALL SHELF BRACKET

- > For shelf thickness: 3/4"
- > For shelf depth: max. 10"
- > Weight capacity: max. 50 lbs.
- > L x W x H: 2" x 2 1/2" x 3 5/8"



**Material**

Aluminum

Finish	Item No.
matt aluminum	792.02.060

## COVER CAP

- > W x D x H: 1 1/2" x 1/2" x 11/16"



**Material**

Plastic

Color	Item No.
black	792.02.349

# OMNI TRACK®

> Hooks are used with wall track 792.00.000

**Note**

Cover cap 792.02.399 is required, see page 87.



## SCREWDRIVER HOOK

> Organizes two screwdrivers and other small tools  
> L x W x H: 1 9/16" x 2 11/16" x 3 3/16"



**Material**  
Steel

Finish	Item No.
matt aluminum	792.02.252

## SINGLE HOOK

> For general use  
> L x W x H: 5 3/8" x 1 1/2" x 1 13/16"



**Material**  
Steel

Finish	Item No.
matt aluminum	792.02.253

## HAND TOOL HOOK

> Organizes hammers and other small tools  
> L x W x H: 5 1/8" x 2 5/8" x 1 15/16"



**Material**  
Steel/Rubber-Coated

Finish/Color	Item No.
matt aluminum/black	792.02.255

## PAPER ORGANIZER

> Organizes rolls of wrapping paper or paper towels  
> L x W x H (one side):  
6 1/4" x 4 11/16" x 5 5/8"

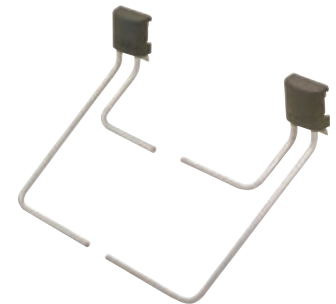

**Material**  
Steel

Finish	Item No.
matt aluminum	792.02.254

## WRENCH HOOK

> Organizes two wrenches and other small tools  
> L x W x H: 1 3/8" x 2 1/8" x 2"



**Material**  
Steel

Finish	Item No.
matt aluminum	792.02.251

## PLIERS HOOK

> Organizes pliers and other small tools  
> L x W x H: 1 5/16" x 2 7/16" x 2"



**Material**  
Steel

Finish	Item No.
matt aluminum	792.02.250

# OMNI TRACK®

> Hooks and storage bins are used with wall track 792.00.000



## BASKET HOOK

> For use with closet baskets, 547.xx.xxx, see page 53.  
> L x W x H: 7/8" x 1 1/2" x 3 1/2"

**Material**  
Steel



Finish	Item No.
matt aluminum	792.02.007

**Note** Cover cap 792.02.399 is required.

## COVER CAP

> W x D x H: 1 1/16" x 11/16" x 1 1/2"

**Material**  
Plastic



Color	Item No.
black	792.02.399

## STORAGE BINS

> Hook to wall track 792.00.000  
> With label slots on front

**Material/Color**  
Plastic, black



W x D x H	Item No.
4 1/4" x 5 1/4" x 3"	792.02.380
4 1/4" x 7 1/4" x 3"	792.02.381
5 1/2" x 10 3/4" x 5"	792.02.382

## LEVELERS WITH 1" ADJUSTMENT

> Easy to cut with saw blade for custom lengths  
> Static weight rating: 352 lbs.  
> W x D: 3 1/2" x 2"

**Material/Color**  
Tube: Aluminum; Foot: Plastic, black



Height	matt aluminum	Height	black
3 1/2"	792.01.080	3"	792.01.380
6"	792.01.081	6"	792.01.381
9"	792.01.082	9"	792.01.382
12"	792.01.083	-	-

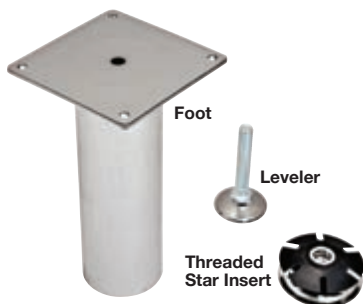

## GARAGE FEET

> Specifically designed for demanding garage applications  
> Coated with a special resin clear coat which is resistant to UV rays, and salt spray tested to 200 hours  
> Feet can be cut to length if required

**Material/Color:**  
Nickel-plated, brushed and resin epoxy-coated, matt  
Threaded Insert: Steel, matt; Leveler: Steel; Foot: Nylon, matt white

Height	Item No.
6"	635.48.060
12"	635.48.061

**Supplied with**  
4 Feet, Threaded inserts and levelers, 16 Mounting screws, #8 x 3/4"



# OMNI TRACK® CLOSET

> Hooks are used with wall track 792.00.000

**Note**

Cover cap 792.02.099 is required.



## TIE HOOK

- > Holds 8 ties
- > W x D x H: 4 1/16" x 1 7/8" x 4 3/4"

**Material**  
Steel



Finish	Item No.
matt aluminum	792.03.900

## BRACELET HOOK

- > Holds bracelets, necklaces and other jewelry
- > W x D x H: 9" x 3 11/16" x 2 1/2"

**Material**  
Steel



Finish	Item No.
matt aluminum	792.03.940

## BELT HOOK

- > Holds 4 belts
- > W x D x H: 3 3/8" x 2 13/16" x 5 9/16"

**Material**  
Steel



Finish	Item No.
matt aluminum	792.03.910

## VALET HOOK

- > Holds clothes on hangers
- > W x D x H: 1 1/2" x 3 3/4" x 4 15/16"

**Material**  
Steel



Finish	Item No.
matt aluminum	792.03.950

## DOUBLE HOOK

- > Holds jewelry, hats, ironing board, etc.
- > W x D x H: 3 5/8" x 2 5/8" x 2 1/16"

**Material**  
Steel



Finish	Item No.
matt aluminum	792.03.920

## COAT HOOK

- > With rounded top
- > W x D x H: 2 3/16" x 2 1/16" x 6 1/4"

**Material**  
Steel



Finish	Item No.
matt aluminum	792.03.930

## COVER CAP

- > W x D x H: 1 11/16" x 1 1/16" x 1 9/16"

**Material**  
Plastic



Color	Item No.
silver	792.02.099

# OMNI TRACK® OFFICE

> Accessories are used with wall track 792.00.000



## PAPER TRAY

- > Holds 8 1/2" x 11" paper
- > W x D x H: 13 1/4" x 9 5/8" x 7/8"



**Material**  
Steel

Finish	Item No.
silver	818.83.910

## PENCIL TRAY

- > Holds pencils and other small items
- > W x D x H: 7 3/4" x 3 5/8" x 7/8"



**Material**  
Steel

Finish	Item No.
silver	818.83.920

## SMALL TRAY

- > Holds paper clips and other small items
- > W x D x H: 2 3/4" x 3 3/8" x 7/8"



**Material**  
Steel

Finish	Item No.
silver	818.83.930

## UPRIGHT TRAY

- > Holds pens, pencils and other small items
- > W x D x H: 3 1/4" x 1 9/16" x 3 1/2"



**Material**  
Steel

Finish	Item No.
silver	818.83.940

## FILE HANGER

- > Holds 8 1/2" x 11" hanging file folders
- > A second file hanger can be added on the front for additional storage
- > W x D x H: 12 1/4" x 2 13/16" x 4"



**Material**  
Steel

Finish	Item No.
silver	818.83.900

## J CHANNEL

- > Used to create a cork board or white board solution
- > L x W x H: 97" x 7/16" x 1 1/2"



**Material**  
Aluminum

Finish	Item No.
matt aluminum	792.01.045

# HandiKITS™



**BASIC ACCESSORY KIT**

			Item No.
			792.15.031
Description	Model No.	Item No.	Qty.
Basket, 8" x 12"	HSB0812B	792.12.010	1
Basket, 12" x 24"	HSB1224B	792.12.030	1
Loop Hook, 4"	HSH04LBWL	792.12.050	1
Loop Hook, 8"	HSH08LBWL	792.12.051	1
Double Hook, 4"	HSH04DBWL	792.12.060	2
Double Hook, 8"	HSH08DBWL	792.12.061	1
Snap Hook, 1"	HSH01SH	792.12.070	3
Snap Hook, 4"	HSH04SH	792.12.071	6
J Hook, 6"	HSH06JBWL	792.12.080	1
Long Tool Bar with Hooks, 24"	HSH03SBWL	792.12.090	1

**Note**

Requires a 4' x 8' section (1 carton) of HandiWALL panels.



**WORK BENCH ACCESSORY KIT**

			Item No.
			792.15.071
Description	Model No.	Item No.	Qty.
Basket, 8" x 12"	HSB0812B	792.12.010	1
Snap Hook, 4"	HSH04SH	792.12.071	3
9 Tilt Bin Storage Unit	HSB09TOB	792.14.050	1
6 Tilt Bin Storage Unit	HSB06TOB	792.14.051	1
Screwdriver Rack	HSSDHB	792.14.060	1
Magnetic Tool Bar, 13"	HSH13THB	792.14.070	1
Multi-Purpose Roll Holder	HSMPRH	792.14.080	1
Locking Accessory Clip, black	HSHN3PAC	792.15.300	3

**Note**

Requires a 4' x 8' section (1 carton) of HandiWALL panels.



**INTERMEDIATE ACCESSORY KIT**

			Item No.
			792.15.041
Description	Model No.	Item No.	Qty.
Basket, 8" x 12"	HSB0812B	792.12.010	1
Basket, 12" x 18"	HSB1218B	792.12.020	1
Basket, 12" x 24"	HSB1224B	792.12.030	1
Loop Hook, 4"	HSH04LBWL	792.12.050	1
Loop Hook, 8"	HSH08LBWL	792.12.051	2
Double Hook, 4"	HSH04DBWL	792.12.060	3
Double Hook, 8"	HSH08DBWL	792.12.061	2
Snap Hook, 1"	HSH01SH	792.12.070	3
Snap Hook, 4"	HSH04SH	792.12.071	6
Snap Hook, 6"	HSH06SH	792.12.072	3
Snap Hook, 8"	HSH08SH	792.12.073	3
J Hook, 6"	HSH06JBWL	792.12.080	1
Long Tool Bar with Hooks, 24"	HSH03SBWL	792.12.090	1
Shelf, 14" x 24"	HSS1424B	792.13.030	1
Shoe Rack, 14" x 24"	HSS2414G	792.22.300	1

**Note**

Requires a 4' x 16' section (2 cartons) of HandiWALL panels.

# HandiKITS™



**DELUXE ACCESSORY KIT**

			Item No. 792.15.051
Description	Model No.	Item No.	Qty.
Basket, 8" x 12"	HSB0812B	792.12.010	2
Basket, 12" x 18"	HSB1218B	792.12.020	1
Basket, 12" x 24"	HSB1224B	792.12.030	1
Loop Hook, 4"	HSH04LBWL	792.12.050	1
Loop Hook, 8"	HSH08LBWL	792.12.051	2
Double Hook, 4"	HSH04DBWL	792.12.060	4
Double Hook, 8"	HSH08DBWL	792.12.061	3
Snap Hook, 1"	HSH01SH	792.12.070	6
Snap Hook, 4"	HSH04SH	792.12.071	6
Snap Hook, 6"	HSH06SH	792.12.072	6
Snap Hook, 8"	HSH08SH	792.12.073	3
J Hook, 6"	HSH06JBWL	792.12.080	2
Long Tool Bar with Hooks, 24"	HSH03SBWL	792.12.090	2
Shelf, 14" x 24"	HSS1424B	792.13.030	1
Shelf, 14" x 48"	HSS1448B	792.13.040	1
Shoe Rack, 14" x 24"	HSS2414G	792.22.300	2

**Note**  
Requires a 4' x 16' section (2 cartons) of HandiWALL panels.



**GARDEN CENTER ACCESSORY KIT**

			Item No. 792.15.091
Description	Model No.	Item No.	Qty.
Basket, 12" x 18"	HSB1218B	792.12.020	1
Garden Center	HSGCNL	792.12.040	1
Loop Hook, 8"	HSH08LBWL	792.12.051	1
Double Hook, 4"	HSH04DBWL	792.12.060	1
Double Hook, 8"	HSH08DBWL	792.12.061	1
J Hook, 6"	HSH06JBWL	792.12.080	2
Long Tool Bar with Hooks, 24"	HSH03SBWL	792.12.090	1
S Hook	HSSHKBNL	792.13.000	2
Double Utility Hook	HSDUHBWL	792.13.010	1
Shelf, 14" x 24"	HSS1424B	792.13.030	2

**Note**  
Requires a 4' x 8' section (1 carton) of HandiWALL panels.



**GOLF ACCESSORY KIT**

			Item No. 792.15.060
Description	Model No.	Item No.	Qty.
Basket, 8" x 12"	HSB0812B	792.12.010	1
Double Hook, 4"	HSH04DBWL	792.12.060	1
Snap Hook, 4"	HSH04SH	792.12.071	1
Shelf, 14" x 24"	HSS1424B	792.13.030	1
Shoe Rack, 14" x 24"	HSS2414G	792.22.300	1
Golf Accessory Holder	HSGAHB	792.13.060	1

**Note**  
Requires a 4' x 8' section (1 carton) of HandiWALL panels.



**SPORTS ACCESSORY KIT**

			Item No. 792.15.081
Description	Model No.	Item No.	Qty.
Basket, 8" x 12"	HSB0812B	792.12.010	1
Double Hook, 4"	HSH04DBWL	792.12.060	1
Double Hook, 8"	HSH08DBWL	792.12.061	3
J Hook, 6"	HSH06JBWL	792.12.080	1
Tennis Accessory Holder	HSTAHNL	792.13.090	1
Horizontal Bike Rack	HSHBRNL	792.14.010	1
Large Mesh Storage Basket	HLSLB3426B	792.14.030	1

**Note**  
Requires a 4' x 8' section (1 carton) of HandiWALL panels.

## HandiWALL®

- > Manufactured in the USA with blended Cellular PVC material that has a flame retardant rating of 94 V-O
- > Scratch resistant with normal use; color throughout the product makes surface scratches less noticeable
- > Smooth satin finish gives high end aesthetic appeal
- > Color coordinated installation screws and trim available
- > Water and moisture resistant; Strong and durable; Easy to clean

### Note

32 square feet per carton

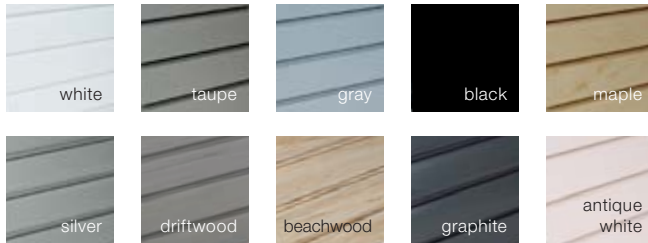

### PANELS

- > Weight capacity: 100 lbs./square ft.
- > W x L: 12" x 8'

### Material

Cellular PVC

Color	Model No.	Item No.
white	HSW1008	792.10.721
taupe	HSW2008	792.10.621
gray	HSW3008	792.10.521
black	HSW4008	792.10.321
maple	HSW5008	792.10.121
silver	HSW15008	792.10.931
driftwood	HSW16008	792.10.821
antique white	HSW8008	792.10.731
beachwood	HSW14008	792.10.021
graphite	HSW13008	792.10.431

### Supplied With

4 Panels/carton

### HANDISCREWS™

Color matched to the various HandiWALL colors ensuring a seamless application and appearance. Steel construction provides a heavy-duty installation.

### FLAT HEAD TAPCON® SCREWS

- > Ø x L: 3/16" x 1 3/4"

### Material

Steel



Color	Model No.	Item No.	Packing
white	HSWS100WTC	792.16.730	1000 pcs.
taupe	HSWS200TTC	792.16.630	1000 pcs.
gray	HSWS300GTC	792.16.530	1000 pcs.
maple	HSWS500MTC	792.16.130	1000 pcs.
black	HSWS400BTC	792.16.380	1000 pcs.
graphite	HSWS1308GTC	792.16.480	1000 pcs.



### DRYWALL SCREWS

### Material

Steel



- > Length: 1 5/8"

Color	Model No.	Item No.	Packing
white	HSWS100W	792.16.700	1000 pcs.
white	HSWS100TBK	792.16.701	100 pcs.
taupe	HSWS200T	792.16.600	1000 pcs.
taupe	HSWS200TBK	792.16.601	100 pcs.
gray	HSWS300G	792.16.500	1000 pcs.
gray	HSWS300TBK	792.16.501	100 pcs.
black	HSWS400B	792.16.300	1000 pcs.
black	HSWS400BTBK	792.16.301	100 pcs.
maple	HSWS500M	792.16.100	1000 pcs.
maple	HSWS500TBK	792.16.101	100 pcs.
silver	HSWS1500S	792.16.900	1000 pcs.
silver	HSWS1500STBK	792.16.901	100 pcs.
driftwood	HSWS1600S	792.16.400	1000 pcs.
driftwood	HSWS1600STBK	792.16.401	100 pcs.
antique white	HSWS800AW	792.16.710	1000 pcs.
antique white	HSWS800TBK	792.16.711	100 pcs.
beachwood	HSWS1400BW	792.16.000	1000 pcs.
beachwood	HSWS1400BWTBK	792.16.001	100 pcs.
graphite	HSWS1308G	792.16.410	1000 pcs.
graphite	HSWS1308GTBK	792.16.411	100 pcs.

- > Length: 2 1/2"

Color	Model No.	Item No.	Packing
white	HSWS125W	792.16.760	1000 pcs.
taupe	HSWS225T	792.16.660	1000 pcs.
gray	HSWS325G	792.16.560	1000 pcs.
maple	HSWS525M	792.16.160	1000 pcs.
silver	HSWS1525S	792.16.960	1000 pcs.
driftwood	HSWS1625S	792.16.460	1000 pcs.
antique white	HSWS825AW	792.16.770	1000 pcs.
beachwood	HSWS1425BW	792.16.060	1000 pcs.
graphite	HSWS1325G	792.16.470	1000 pcs.

# HandiTRIM™

- > Wide array of extrusions help to finish off the HandiWALL® installation
- > Designed to frame out your wall, eliminate seams and make 90° angle connections visually appealing.

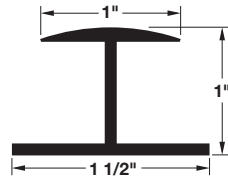

## DIVISION MOLDINGS

> Length: 96"

### Material

Cellular PVC

Color	Model No.	Item No.
white	HST1096D	792.10.742
taupe	HST2096D	792.10.642
gray	HST3096D	792.10.542
black	HST4096D	792.10.342
maple	HST5096D	792.10.142
silver	HST15096D	792.10.952
driftwood	HST16096D	792.10.842
antique white	HST8096D	792.10.752
beachwood	HST14096D	792.10.042
graphite	HST13096D	792.10.452

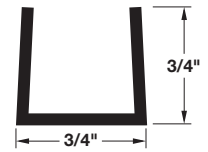
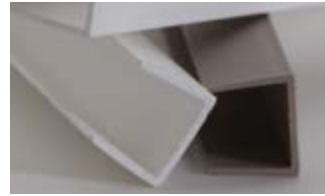

## INDENTED EDGE CAPS

> Length: 96"

### Material

Cellular PVC

Color	Model No.	Item No.
white	HST1096E	792.10.762
taupe	HST2096E	792.10.662
gray	HST3096E	792.10.562
black	HST4096E	792.10.362
maple	HST5096E	792.10.162
silver	HST15096E	792.10.972
driftwood	HST16096E	792.10.862
antique white	HST8096E	792.10.772
beachwood	HST14096E	792.10.062
graphite	HST13096E	792.10.472

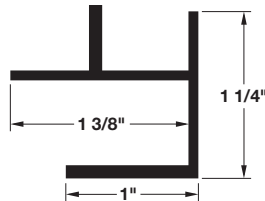
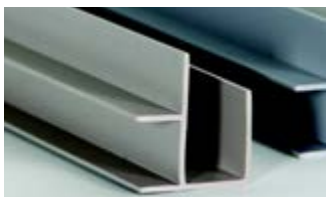

## INSIDE/OUTSIDE CORNER MOLDINGS

> Length: 96"

### Material

Cellular PVC

Color	Model No.	Item No.
white	HST1096M	792.11.702
taupe	HST2096M	792.11.602
gray	HST3096M	792.11.502
black	HST4096M	792.11.302
maple	HST5096M	792.11.102
silver	HST15096M	792.11.912
driftwood	HST16096M	792.11.802
antique white	HST8096M	792.11.712
beachwood	HST14096M	792.11.002
graphite	HST13096M	792.11.412

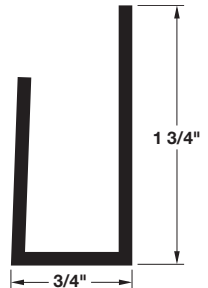
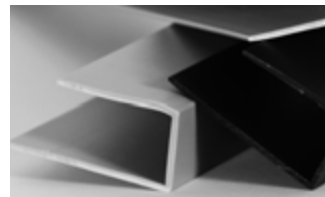

## LARGE J MOLDINGS

> Length: 96"

### Material

Cellular PVC

Color	Model No.	Item No.
white	HST1096L	792.10.782
taupe	HST2096L	792.10.682
gray	HST3096L	792.10.582
black	HST4096L	792.10.382
maple	HST5096L	792.10.182
silver	HST15096L	792.10.992
driftwood	HST16096L	792.10.882
antique white	HST8096L	792.10.792
beachwood	HST14096L	792.10.082
graphite	HST13096L	792.10.492

# HandiTRIM™

- > Use to hide screws or as decorative accent to add color to HandiWALL®
- > Each color strip includes self-adhesive tape on the back to ensure the strip remains securely in place
- > Color strips will not affect installation of accessories



## HANDI COLOR STRIPS

> Length: 96"

**Material**  
ABS Plastic

Color	Model No.	Item No.
white	HSCST1008-30	792.11.750
taupe	HSCST2008-30	792.11.650
gray	HSCST3008-30	792.11.550
black	HSCST4008-30	792.11.350
maple	HSCST5008-30	792.11.150
silver	HSCST15008-30	792.11.950
driftwood	HSCST21008-30	792.11.850
antique white	HSCST8008-30	792.11.760
beachwood	HSCST14008-30	792.11.050
graphite	HSCST13008-30	792.11.460

**Supplied With**  
30 pcs. per package

**Note**  
Image shows finishes in table order.

# HandiACCESSORIES™

## HOOKS

- > Wide variety of steel constructed hooks and brackets for maximum strength
- > Durable wire construction allows for easy mounting to HandiWALL®
- > Hooks are rubber coated for secure gripping with a rust-resistant powder-coated finish
- > Ideal for long handled tools, cords, folding chairs, ladders, heavy tools, and much more

### Note

Locking feature: The hook engages automatically when installing, and once seated into the slot of the HandiWALL® the lock will then close and hold it firmly in place. To remove it, simply press down on the spring-loaded lock.



### LOOP HOOK, LENGTH: 4"

- > Weight capacity: 30 lbs.
- > Includes locking feature

#### Material/Finish

Steel, powder-coated/Soft Vinyl, graphite



Model No.	Item No.
HSH04LBWL	792.12.050

### LOOP HOOK, LENGTH: 8"

- > Weight capacity: 40 lbs.
- > Includes locking feature

#### Material/Finish

Steel, powder-coated/Soft Vinyl, graphite



Model No.	Item No.
HSH08LBWL	792.12.051

### DOUBLE HOOK, LENGTH: 4"

- > Weight capacity: 40 lbs.
- > Includes locking feature

#### Material/Finish

Steel, powder-coated/Soft Vinyl, graphite



Model No.	Item No.
HSH04DBWL	792.12.060

### SNAP HOOK, LENGTH: 1"

#### Material/Finish

Steel, powder-coated, graphite



Model No.	Item No.
HSH01SH	792.12.070

### SNAP HOOK, LENGTH: 4"

#### Material/Finish

Steel, powder-coated, graphite

Model No.	Item No.
HSH04SH	792.12.071

### SNAP HOOK, LENGTH: 6"

#### Material/Finish

Steel, powder-coated, graphite

Model No.	Item No.
HSH06SH	792.12.072

### SNAP HOOK, LENGTH: 8"

#### Material/Finish

Steel, powder-coated, graphite

Model No.	Item No.
HSH08SH	792.12.073



# HandiACCESSORIES™

## HOOKS

- > Wide variety of steel constructed hooks and brackets for maximum strength
- > Durable wire construction allows for easy mounting to HandiWALL®
- > Hooks are rubber coated for secure gripping with a rust-resistant powder-coated finish
- > Ideal for long handled tools, cords, folding chairs, ladders, heavy tools, and much more

### Note

Locking feature: The hook engages automatically when installing, and once seated into the slot of the HandiWALL® the lock will then close and hold it firmly in place. To remove it, simply press down on the spring-loaded lock.



### DOUBLE HOOK, LENGTH: 8"

- > Weight capacity: 50 lbs.
- > Includes locking feature

#### Material/Finish

Steel, powder-coated/Soft Vinyl, graphite



Model No.	Item No.
HSH08DBWL	792.12.061

### J HOOK, LENGTH: 6"

- > Weight capacity: 40 lbs.
- > Includes locking feature

#### Material/Finish

Steel, powder-coated/Soft Vinyl, graphite



Model No.	Item No.
HSH06JBWL	792.12.080

### TOOL BAR WITH HOOKS, LENGTH: 24"

- > Weight capacity: 60 lbs.
- > Includes locking feature

#### Material/Finish

Steel, powder-coated/Soft Vinyl, graphite



Model No.	Item No.
HSH03SBWL	792.12.090

### S HOOK

#### Material/Finish

Steel, powder-coated/Soft Vinyl, graphite



Model No.	Item No.
HSSHKBNL	792.13.000

### DOUBLE UTILITY HOOK

- > Weight capacity: 40 lbs.
- > Includes locking feature

#### Material/Finish

Steel, powder-coated/Soft Vinyl, graphite



Model No.	Item No.
HSDUHBWL	792.13.010

### GARMENT HOOK

#### Material/Finish

Steel, powder-coated, graphite



Model No.	Item No.
HSHGHPK	792.13.020

#### Supplied With

6 pcs.

# HandiACCESSORIES™



## SHELVES

- > Shelves help organize, add functionality, and clear all that clutter from the floor
- > Durable wire construction with a rust-resistant powder-coated finish

### Material/Finish

Steel, powder-coated, graphite

W x D x H	Weight Capacity	Model No.	Item No.
24" x 14 3/8" x 6"	75 lbs.	HSS1424B	792.13.030
48" x 14 3/8" x 6"	125 lbs.	HSS1448B	792.13.040

## SHOE RACK

- > W x D x H: 24" x 14 3/4" x 6 15/16"
- > Weight capacity: 15 lbs.

### Material/Finish

Steel, powder-coated, graphite

Model No.	Item No.
HSS2414G	792.22.300



## BASKET-MINI BIN KIT

- > Clear bins provide visibility to contents
- > Bins can be stacked
- > Additional bins can be purchased separately
- > H x W x D: 5 3/8" x 13" x 24 3/8"

### Material/Finish

Shelf: Steel, powder-coated, graphite; Bins: Plastic

Item No.
792.22.430

### Supplied With

- 1 Shelf
- 3 Bins with lids



## MINI BIN PACK, OPTIONAL

- > Lids do not snap into place; they rest on top of the bins
- > H x W x D: 5 3/8" x 12 1/4" x 8"

### Material

Plastic

Item No.
792.22.431

### Supplied With

- 3 Bins with lids

# HandiACCESSORIES™



## BASKETS

- > Designed to easily secure to HandiWALL®
- > Several convenient sizes for endless storage configurations

### Material/Finish

Steel, powder-coated, graphite

W x D x H	Weight Capacity	Model No.	Item No.
12 1/8" x 3 5/8" x 3 1/4"	20 lbs.	HSB0312B	792.12.000
11 7/8" x 8 1/2" x 7 3/4"	40 lbs.	HSB0812B	792.12.010
17 7/8" x 12 3/4" x 7 5/8"	60 lbs.	HSB1218B	792.12.020
23 7/8" x 12 3/8" x 4 3/4"	60 lbs.	HSB1224B	792.12.030

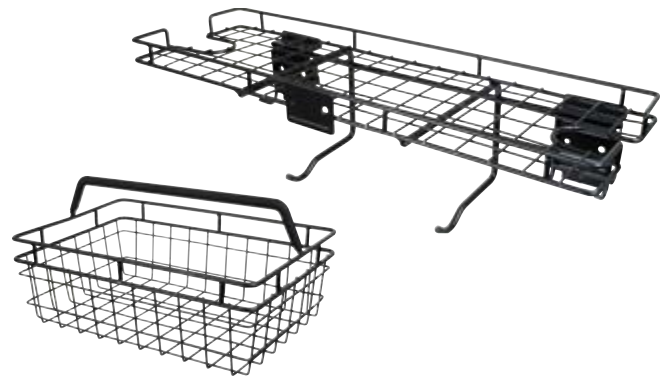

## GARDEN CENTER

- > Designed with a detachable hanging basket to carry your tools where you need them
- > W x D x H: 22 1/4" x 8 1/2" x 12 1/8"
- > Basket W x D x H: 12" x 8" x 4"

### Material/Finish

Steel, powder-coated, graphite

Model No.	Item No.
HSGCNL	792.12.040



## HANDITUB

- > Includes shelf and removable tub
- > Designed to prevent tub from tilting forward when opening and closing
- > Tub includes clear window for labeling
- > W x D x H: 14" x 17" x 13"

### Material/Finish

Frame: Steel, powder-coated, black; Tub: Plastic, smoke

Item No.
792.22.340

# HandiACCESSORIES™

## SPORTS

- > Sports storage accessories store and protect all your expensive sporting gear and much more
- > Multi-functional and durable providing a clutter-free environment
- > All accessories easily attach to the HandiWALL®

**Note**

Locking feature: The hook engages automatically when installing, and once seated into the slot of the HandiWALL® the lock will then close and hold it firmly in place. To remove it, simply press down on the spring-loaded lock.



### HORIZONTAL BIKE HOOK

- > Includes locking feature
- > W x D x H: 2 7/8" x 15 1/8" x 8 1/4"

**Material/Finish**

Steel, powder-coated/Soft Vinyl, graphite

Model No.	Item No.
HSHBHWL	792.22.310

### FAT TIRE BIKE HOOK

- > Includes locking feature
- > W x D x H: 6 1/4" x 9" x 8"

**Material/Finish**

Steel, powder-coated/Soft Vinyl, graphite

Model No.	Item No.
HSHFTBHWL	792.22.320



### HORIZONTAL BIKE RACK

- > W x D x H:  
19 1/2" x 14" x 7 3/8"

**Material/Finish**

Steel, powder-coated, graphite

Model No.	Item No.
HSHBRNL	792.14.010



### BIKE HOOK, LENGTH: 5"

- > Includes locking feature
- > W x D x H: 3 3/8" x 5 7/8" x 4 1/8"

**Material/Finish**

Steel, powder-coated/Soft Vinyl, graphite

Model No.	Item No.
HSH05BWL	792.13.070



# HandiACCESSORIES™

## SPORTS

- > Sports storage accessories store and protect all your expensive sporting gear and much more
- > Multi-functional and durable providing a clutter-free environment
- > All accessories easily attach to the HandiWALL®

### Note

Locking feature: The hook engages automatically when installing, and once seated into the slot of the HandiWALL® the lock will then close and hold it firmly in place. To remove it, simply press down on the spring-loaded lock.



### GOLF ACCESSORY HOLDER

- > W x D x H:  
18 5/8" x 3 3/8" x 8 1/4"

#### Material/Finish

Steel, powder-coated, graphite



Model No.	Item No.
HSGAHB	792.13.060

### SPORTS ACCESSORY RACK

- > W x D x H:  
27" x 13" x 18 1/4"

#### Material/Finish

Steel, powder-coated, graphite

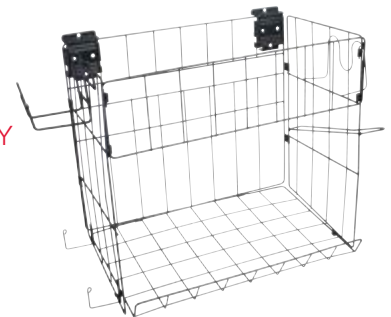

Model No.	Item No.
HSSAR	792.13.080

### SKI RACK

- Includes locking feature
- W x D x H: 4 3/4" x 5 1/2" x 3 5/8"

#### Material/Finish

Steel, powder-coated/Soft Vinyl, graphite



Model No.	Item No.
HSSRHWL	792.14.020

### TENNIS ACCESSORY HOLDER

- > W x D x H:  
14 3/4" x 5 1/8" x 3 3/8"

#### Material/Finish

Steel, powder-coated, graphite



Model No.	Item No.
HSTAHNL	792.13.090

### LARGE MESH STORAGE BASKET

- > W x D x H:  
33 3/4" x 17 1/4" x 26"

#### Material/Finish

Steel, powder-coated, graphite



Model No.	Item No.
HLSB3426B	792.14.030

### FISHING ROD HOLDER

- > W x D x H:  
25 3/8" x 2 7/8" x 9 3/4"

#### Material/Finish

Steel, powder-coated, graphite



Model No.	Item No.
HSFRHNL	792.14.000

# HandiACCESSORIES™

## TOOL STORAGE/WORK SHOP

- > Versatile, durable tool storage accessories provide easy access and organization of all your hand tools
- > Avoid an unorganized tool box by selecting magnetic tool bars or various functional tool grip racks



## MAGNETIC TOOL BAR

### WIDTH: 24"

- > W x D x H:  
24" x 1 1/8" x 1 5/8"

**Material**  
Steel



Model No.	Item No.
HSH24THB	792.14.071

**Note**

Locking Accessory Clip, item 792.15.300 is required.

### WIDTH: 13"

- > W x D x H: 13" x 1 1/8" x 1 5/8"

**Material**  
Steel



Model No.	Item No.
HSH13THB	792.14.070

## SCREWDRIVER RACK

- > W x D x H: 7 1/8" x 2 1/8" x 3 1/4"

**Material/Finish**  
Steel, graphite

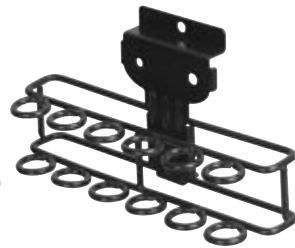

Model No.	Item No.
HSSDHB	792.14.060

## PAPER TOWEL HOLDER

- > W x D x H:  
13 7/16" x 3" x 3 3/4"

**Material/Finish**  
Steel, graphite



Model No.	Item No.
HSPTH	792.14.090

## MULTI-PURPOSE ROLL HOLDER

- > W x D x H (each):  
2 7/8" x 3 1/8" x 3 1/4"

**Material/Finish**  
Steel, graphite



Model No.	Item No.
HSMPRH	792.14.080

## LOCKING ACCESSORY CLIP

- > Required for tilt bins and magnetic tool bar
- > W x D x H: 1" X 1 1/2" X 3 1/2"

**Material/Finish**  
Steel, graphite



Model No.	Item No.
HSHN3PAC	792.15.300

**Supplied With**

- 2 Clips
- 2 Nuts
- 2 Screws

# HandiACCESSORIES™

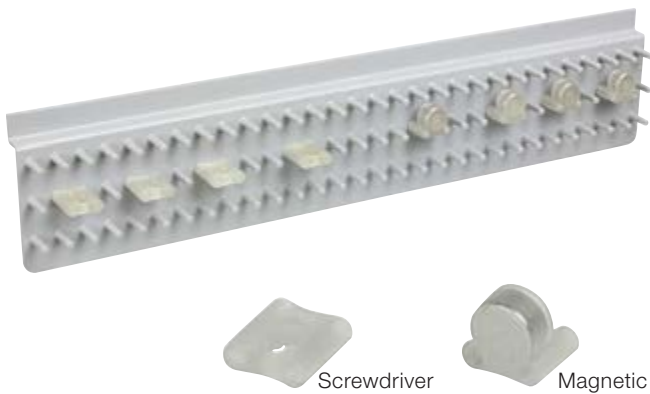

## POCKET KITS, OPTIONAL

Version	Item No.
Magnetic	792.22.450
Screwdriver	792.22.451

**Supplied With**  
6 pcs. per kit

## MAGNETIC TOOLPADS

- > Fits directly onto HandiWALL®
- > Color coordinated to blend in perfectly with HandiWALL® panels
- > Length: 15"

**Material**  
Plastic

Color	Item No.
white	792.22.760
taupe	792.22.660
gray	792.22.560
black	792.22.360
maple	792.22.160
graphite	792.22.460
beachwood	792.22.060
silver	792.22.960
driftwood	792.22.860

**Supplied With**

- 6 Magnetic pockets
- 6 Screwdriver pockets
- 2 Twist Locks to secure the ToolPAD in place on the HandiWALL®

**Note**

Pockets can be purchased separately if additional are needed.

# HandiACCESSORIES™

## STORAGE BINS

- > Organize small parts
- > Bins attach securely and remove effortlessly
- > Tilt bins feature a transparent bin that tips out at a 45° angle
- > Clear bins provide a complete view of small items



## TILT BINS

### Material

Plastic, clear



Compartments	W x D x H	Model No.	Item No.
9	23 5/8" x 2 5/8" x 3"	HSB09TOB	792.14.050
6	23 5/8" x 3 5/8" x 4 3/8"	HSB06TOB	792.14.051

### Note

Locking Accessory Clip, item 792.15.300 is required, see page 101.

## UTILITY BINS

- > W x D x H: 4 7/8" x 5 3/8" x 4 1/2"



### Material

Plastic

Color	Model No.	Item No.
taupe	HSPUB	792.14.640
gray	HSPUBG	792.14.540





## LAUNDRY, PANTRY, WINE & MORE

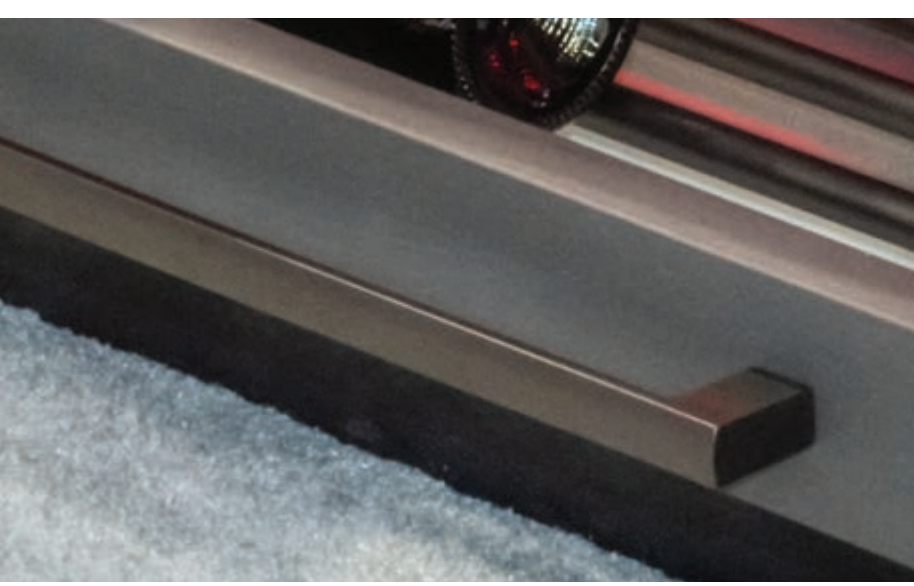

Our homes are as unique as we are. And that means they can be complex, but should also never be messy. This catalog section tackles those spaces with some of the greatest storage opportunities – as well as some of the greatest challenges – laundry areas, pantries, open and hidden wine storage and beyond. Our goal in presenting these solutions is simple: never again will there be a broom which is haphazardly stashed behind a door, a step stool wedged between two larger things and a pile of clothes which is somehow still out in the open.

# HÄFELE MATRIX LAUNDRY HAMPER

**Service+**

*soft&silent)))*

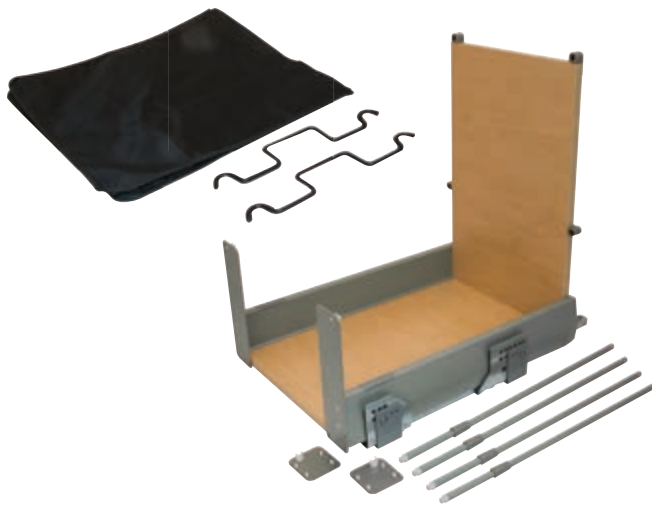

## LAUNDRY HAMPERS 18"

- > For 18" wide base cabinets with no drawer above
- > For vanity or laundry cabinets
- > Progressive action runners with soft close
- > Double wall steel frame system provides heavy duty structure and a stylish design
- > Bottom mount unit designed for face frame or frameless cabinets
- > Quick mounting, bottom bracket rests against the back of the face frame (3/4" from front edge)
- > Add your door thickness for inset applications
- > Weight capacity: 110 lbs.
- > Minimum opening width: Face frame: 14 3/4"; Frameless: 15 1/2"
- > Door brackets are reversible for full overlay 5 piece doors - 16 1/4"
- > L x D: 19 11/16" x 22 3/16"

### Material

Steel; Bottom and Back: Melamine (2-Sided); Bag: Nylon, black

Frame	Bottom and Back	Item No.
white	white	503.15.765
anthracite	black	503.15.365
champagne	maple	503.15.865

### Supplied With

Mounting screws  
Mounting instructions

# HAILO LAUNDRY HAMPERS

- > Sidewall mounted with over extension soft close slides
- > Supplied with a steel lid that can be used for storage or to contain odors
- > Weight capacity: 100 lbs.

*soft&silent*)))



## LAUNDRY HAMPER 45

- > For 18" wide base cabinets
- > W x H x D: 16 1/4"-16 7/16" x 21 7/16" x 20 13/16"
- > Capacity: 2 x 35 qts. (70 qts.)

**Material**

Steel; Hampers: Plastic

Finish/Color	Item No.
white/blue	502.72.722

**Supplied With**

2 Hampers  
Built-in Lid

## LAUNDRY HAMPER 60

- > For 24" wide base cabinets
- > W x H x D: 22 1/8"-22 3/8" x 21 7/16" x 17 5/8"
- > Capacity: 2 x 35 qts. (70 qts.)

**Material**

Steel; Hampers: Plastic

Finish/Color	Item No.
white/blue	502.72.705

## LAUNDRY HAMPER 45 SHORT

- > For 18" wide base cabinets
- > W x H x D: 16 7/16" x 21 7/16" x 17 5/8"
- > Capacity: Hamper - 35 qts.; Bin - 12 qts.

**Material**

Steel; Hampers: Plastic

Finish/Color	Item No.
white/blue	502.72.701

**Supplied With**

1 Laundry hamper - blue  
1 12 quart bin - white  
Built-in Lid



## REPLACEMENT HAMPERS

- > W x D x H: 14 7/8" x 10" x 20 1/2"

**Material**

Plastic

Color	Item No.
white	502.72.990
blue	502.72.993

# WARDROBE RAILS AND VALET

> Perfect for laundry room use



## WARDROBE RAILS

- > Retractable
- > Weight capacity: 22 lbs.

### Material/Finish

Track: Steel, epoxy-coated, almond

Rail: Steel, nickel-plated



Length	Item No.
11 5/8"	805.12.303
13 1/2"	805.12.358
15 1/2"	805.12.401
17 1/2"	805.12.456

## WARDROBE RAILS

- > With plastic runner
- > Retractable

### Material/Finish

Steel, nickel-plated



Length	Weight capacity	Item No.
10 1/4"	17 1/2 lbs.	805.01.752
12 1/4"	13 lbs.	805.01.761

## LAUNDRY VALET

- > For hanging clothing on clothes hangers
- > Four angled positions for the arm
- > L x H: 11" x 10 11/16"
- > Weight capacity: 22 lbs.

### Material

Steel



Finish	Item No.
polished chrome	805.43.250

### Supplied With

Mounting screws

## SWING WARDROBE RAIL

- > Pivotal, screw mounted
- > 180° pivoting range
- > W x D x H: 6 11/16" x 9/16" x 13 3/8"

### Material

Steel; Mounts: Zinc die-cast



Finish	Item No.
chrome-plated	805.40.209

### Supplied With

Mounting screws

# PULL-OUT WINE AND SPICE TRAYS

- > Ideal for storing wine or spices
- > Full extension slides allow for easy access to wine and spice bottles
- > Height: 2 3/8"
- > For 14" deep cabinets

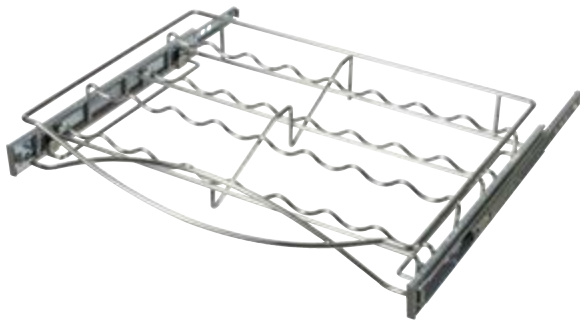
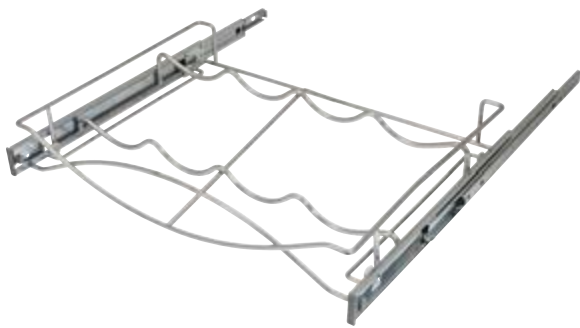

## WINE TRAYS

**Material/Finish**  
Steel, chrome

For interior cabinet width	Storage	Item No.
18"	4 bottles	540.50.114
24"	6 bottles	540.50.117

**Supplied With**  
Full extension slides

## SPICE TRAYS

- > Spices are angled for clear visibility

**Material/Finish**  
Steel, chrome

For interior cabinet width	Storage	Item No.
18"	16 spice jars	540.50.204
24"	22 spice jars	540.50.207

**Supplied With**  
Full extension slides

# WINE STORAGE



Wine Post



Wine Peg



Parallel Rods

## WINE POSTS

- > Stores and displays wine bottles so the label can be viewed from the front
- > Posts are threaded and can be expanded to store 1, 2 or 3 wine bottles
- > Easily attaches to 3/4" substrate from back
- > Ø x Depth: 3/4" x 4"

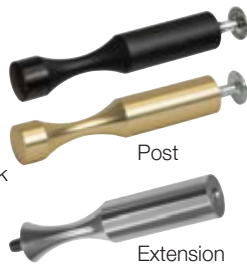

Post

Extension

### Material

Anodized Aluminum

Description	Finish	Item No.
Post	black	521.99.300
Extension		521.99.310
Post	silver	521.99.900
Extension		521.99.910
Post	matt gold	521.99.800
Extension		521.99.810

### Supplied With

1/4-20 screws for 3/4" substrate

## WINE PEGS

- > Stores and displays wine bottles with the neck facing out
- > O-rings help cushion and grip wine bottles and are designed for Bordeaux and Burgundy shaped bottles
- > Easily attaches to 3/4" substrate from back
- > Ø x Depth: 1/2" x 7 1/2"



### Material

Anodized Aluminum

Finish	Item No.
black	521.99.320
silver	521.99.920
matt gold	521.99.820

### Supplied With

1/4-20 screws for 3/4" substrate

## PARALLEL RODS

- > Stores and displays wine bottles so the label can be viewed from the front
- > Rods span between two vertical substrates
- > Internal splines allow rods to be cut and fastened at any length
- > Installs with 1/4-20 screws
- > Allows for flexible design options; accommodates multiple cabinet depths and bottle types
- > Ø: 9/16"



### Material

Anodized Aluminum

Finish	Length	*Storage	Item No.
silver	17"	1 bottle	521.99.931
	27"	2 bottles	521.99.932
	39"	3 bottles	521.99.933
black	17"	1 bottle	521.99.331
	27"	2 bottles	521.99.332
	39"	3 bottles	521.99.333
matt gold	17"	1 bottle	521.99.831
	27"	2 bottles	521.99.832
	39"	3 bottles	521.99.833

### Supplied With

18 pcs.

### Note

Screws are not supplied.

\*Storage is based on the length of the rod. Two rods are required for support.

# WINE STORAGE

- > The parallel rods attach to the brackets to create a ventilated shelf
- > Brackets can be used in a fixed application or add slides for a pull-out shelf
- > 12" length uses 6 parallel rods, 22" length uses 11 parallel rods
- > H x W: 1" x 1/2"

**Note**

For use with parallel rods on previous page.



## PARALLEL ROD BRACKETS

**Material**

Wood/Maple

Depth	Finish	Item No.
12"	black, painted	521.99.340
	unfinished	521.99.140
22"	black, painted	521.99.341
	unfinished	521.99.141

**Supplied With**

Screws to attach parallel rods



Shown with black parallel rods.

# HOLDERS

- > Getting cleaning tools off the floor and onto walls makes them easier to access with our range of holders



## ULTRAHOLD

- > Use in kitchen pantry, garage, workshop, office and storage room
- > Aluminum rail will not rust
- > Non slip covering on hooks
- > Adjustable sliding clamp
- > May be removed from rail and fastened independently to wall
- > Weight capacity: 20 lbs./clamp



### Material

Aluminum, anodized; Clip: Steel

Length	Item No.
18" (4 hooks)	888.00.015
36" (8 hooks)	888.00.024

## BROOMSTICK HOLDERS

- > With four holders
- > For concealed screw mounting
- > L x W x H: 12 1/2" x 1 1/16" x 2 15/16"



### Material

Plastic; Hooks: Steel, nickel-plated, rubber-coated

Color	Item No.
white	520.44.700
gray	520.44.500

## BROOMSTICK HOLDER

- > Screw mounted
- > L x W x H: 2" x 1 9/16" x 1 15/16"



### Material

Steel; Rollers: Rubber

Finish	Item No.
bright galvanized	520.10.009



# HAILO FOLDING STEP STOOL



## MINI COMFORT

- > Folds down for easy storage—just 2 9/16" wide
- > Carry handle features a combined release and go function
- > Non-slip rubber treads
- > With 2 steps covered with non-slip ribbing
- > Weight capacity: 330 lbs.
- > L x W x H: 17 23/32" x 2 3/4" x 23 5/8"

### Material

Legs: Steel; Steps: Aluminum; Feet: Rubber; Handle: Plastic

Finish	Item No.
silver/black	505.03.232



# RACKS, FENCES AND BASKET

> A wide selection of stylish, purposeful racks, baskets and fences that maintain your design vision



## BAKING RACK SUPPORT

> Screw mounted to cabinet base  
> W x D x H: 3" x 12" x 10"



**Material**  
Steel

Finish	Item No.
chrome	540.42.200

## SPICE RACKS

> With screw mounting eyes  
> 4 shelves  
> Depth: 2 5/8"

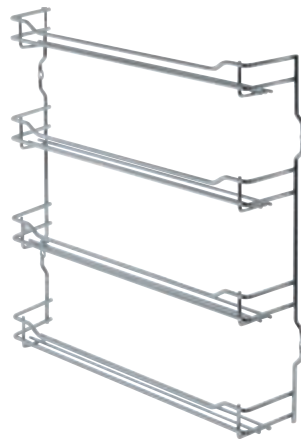

**Material/Finish**  
Steel, chrome

W x H	Item No.
9 5/8" x 15 9/16"	543.19.260
15 3/8" x 15 9/16"	543.19.280

## FENCES FOR WOOD SHELVES

> Press-fits in 5 mm diameter drilled holes  
> Height: 1 1/2"



**Material/Finish**  
Steel, chrome

Length	# Press Fit Plugs	Item No.
9 3/4"	2	547.51.218
11 3/4"	2	547.51.227
13 3/4"	2	547.51.236
15 3/4"	2	547.51.245
17 5/8"	3	547.51.254
21 1/2"	3	547.51.263

## MULTI-PURPOSE BASKET

> Three-sided  
> With screw mounting eyes  
> W x D x H:  
12 1/4" x 4" x 4 1/2"

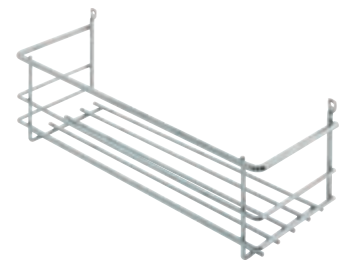

**Material**  
Steel

Finish	Item No.
chrome	540.36.207

# HOME OFFICE

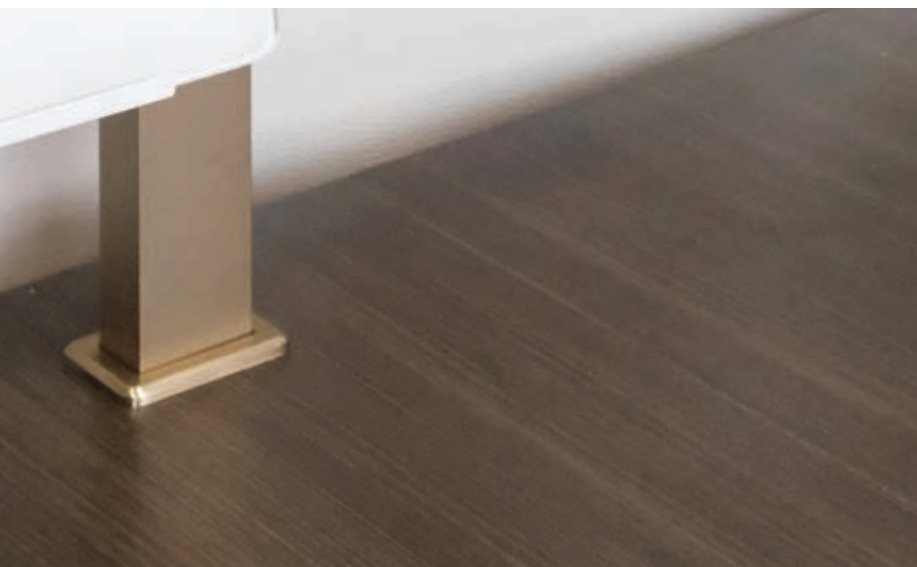

Your customers want purposeful, well-designed work spaces. In order for home-based workers to thrive away from the office, they need customizable functionality and organizational solutions which work for their space, the type of work they're doing and the productivity they strive for. From our TAG Hardware Symphony Office products to monitor arms, charging, wire management and more, Häfele offers everything your home office project demands.

# TAG SYMPHONY

- > Ideal for height adjustable desks
- > Creates vertical storage when a wall is not available
- > Height: 24"



## OFFICE DESK MOUNT KITS

### Material

Aluminum/Vegan Leather

Metal Finish	Leather Color	Width			
		13 1/2"	23"	35"	47"
matt aluminum	oyster	807.71.400	807.71.401	807.71.402	807.71.403
matt aluminum	pewter	807.71.500	807.71.501	807.71.502	807.71.503
matt aluminum	winter	807.71.700	807.71.701	807.71.702	807.71.703
matt gold	oyster	807.71.410	807.71.411	807.71.412	807.71.413
matt gold	pewter	807.71.510	807.71.511	807.71.512	807.71.513
matt gold	winter	807.71.710	807.71.711	807.71.712	807.71.713
matt nickel	oyster	807.71.420	807.71.421	807.71.422	807.71.423
matt nickel	pewter	807.71.520	807.71.521	807.71.522	807.71.523
matt nickel	winter	807.71.720	807.71.721	807.71.722	807.71.723
slate	oyster	807.71.430	807.71.431	807.71.432	807.71.433
slate	pewter	807.71.530	807.71.531	807.71.532	807.71.533
slate	winter	807.71.730	807.71.731	807.71.732	807.71.733
black	oyster	807.71.300	807.71.301	807.71.302	807.71.303
black	pewter	807.71.600	807.71.601	807.71.602	807.71.603
black	winter	807.71.800	807.71.801	807.71.802	807.71.803

### Table Installation

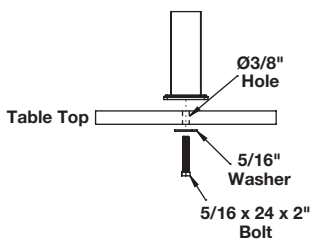

Minimum offset to back wall:

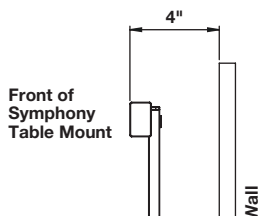

### Supplied With

2 vertical mounts, 4 horizontal bars, Mounting hardware

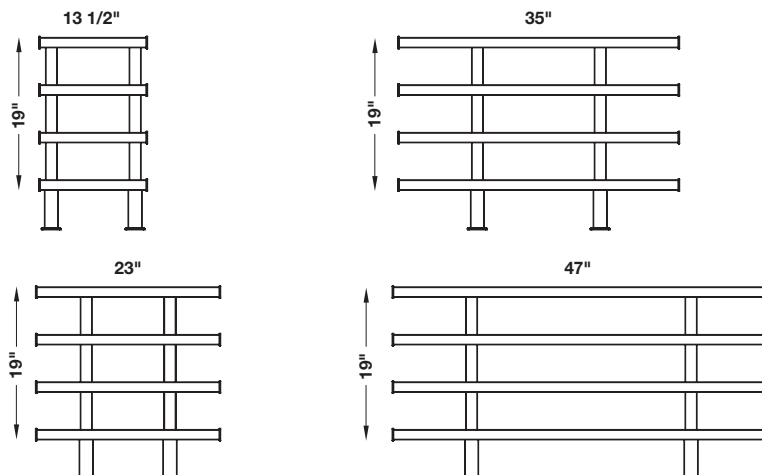

# TAG SYMPHONY OFFICE ACCESSORIES

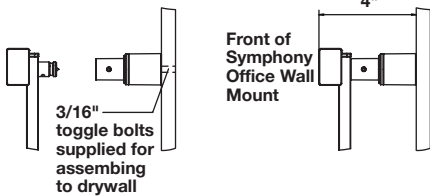

Use #8 wood screws  
for assembling to wood

## EXTENSION ATTACHMENTS

Finish	Item No.
matt aluminum	818.84.000
matt gold	818.84.800
matt nickel	818.84.600
slate	818.84.300
black	818.84.200

### Note

Extensions provide a greater distance from the wall to the backside of the horizontal bars and are required for use with the Symphony office accessories.

# TAG SYMPHONY OFFICE ACCESSORIES

- > Office accessories easily lock into horizontal bars without tools
- > Repositioning on horizontal bars is quick and simple



## TABLET STAND AND GLASS WHITEBOARD

- > Can be used with a tablet or whiteboard
- > Place your tablet at eye level, making it ideal for video calls
- > W x D x H: 7 1/2" x 5 5/8" x 6 3/4"

**Material**

Steel/Glass

Finish	Item No.
white	818.84.730



## PAPER TRAY

- > Holds notebooks, small books and loose documents
- > Magnets can be added to hold additional notes
- > W x D x H: 6 1/4" x 2 3/8" x 6 1/4"

**Material**

Steel

Finish	Item No.
white	818.84.740

# TAG SYMPHONY OFFICE ACCESSORIES

- > Office accessories easily lock into horizontal bars without tools
- > Repositioning on horizontal bars is quick and simple



## PENCIL HOLDER

- > Stores pens, markers, scissors and more
- > W x H: 2 3/4" x 4 3/8"

**Material**

Steel

Finish	Item No.
white	818.84.710



## PENCIL TRAY WITH PLASTIC CONTAINERS

- > Includes hidden hooks to hang small accessories
- > Containers are removable and can be used to store small items like paper clips and USB drives
- > W x H: 7 3/4" x 3 5/8"

**Material**

Steel/Plastic

Finish	Item No.
white	818.84.720

# KEYBOARD AND DESKTOP STORAGE

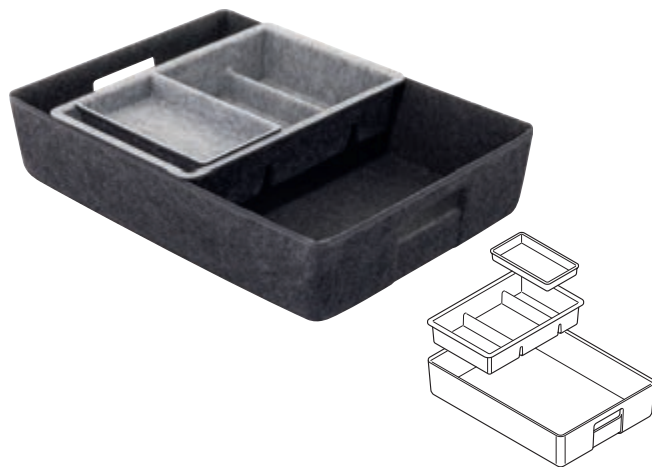

## STANDARD KEYBOARD SYSTEM - MODEL 200

- > 3/4 extension slides
- > Tray tilt, fixed at -7°
- > Detent in the open and closed position
- > Weight capacity: 75 lbs.

**Material**

Steel/Foam/ABS Molded Plastic

Finish	Item No.
black	632.52.300

**Note**

Keyboard and mouse not included.

## DESK TOP STORAGE

- > For storing desk top tools; pens, scissors, staplers, etc.
- > Large bin for storing paper and documents
- > Handle allows for easy transport to other work areas
- > Felt will not damage work surfaces
- > W x D x H: 16 1/2" x 11 3/4" x 3 3/4"

**Material**

Polyester Felt

Drawer/Compartment	Item No.
dark gray/light gray	633.55.090

**Supplied With**

Large bin  
Compartment system set



# PENCIL DRAWERS



## PENCIL DRAWERS FOR SHALLOW APPLICATIONS

- > Shallow 8" depth is designed to fit underneath tables with a support beam, such as adjustable tables
- > With ball bearing slides
- > 4 compartments and a pencil slot
- > Includes a tray that can slide across the drawer or can be removed and placed on the work surface to hold accessories or personal items
- > With wire management slots in the back to holds cords for charging devices such as cell phones
- > W x D x H: 13 5/8" x 8" x 2"

**Material**

Plastic/Steel

Color	Item No.
black	429.59.370
white	429.59.371
silver	429.59.372

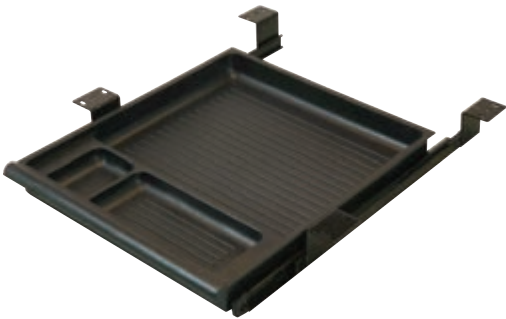

## PENCIL DRAWER

- > 3 compartments
- > Ball bearing slides, with both hold-in and hold-out detents
- > Completely assembled
- > Minimum width required for installation: 15 1/4"
- > Installed depth: 15 1/4"; Extended depth: 26"

**Material**

Plastic/Steel

Finish	Item No.
black	429.59.340

**Supplied With**

Mounting hardware



## PENCIL DRAWER

- > 5 compartments
- > With ball bearing slides
- > Simple assembly required
- > Minimum width required for installation: 23 1/4"
- > Installed depth: 18 1/4"; Extended depth: 29"

**Material**

Plastic/Steel

Finish	Item No.
black	429.59.350

**Supplied With**

Mounting hardware

# MONITOR ARMS

- > German engineered for quality and durability
- > Smooth movement to easily change distance, angle or rotation
- > Stabilis gas spring provides effortless movement
- > Elevates the monitor above the work surface
- > Quick-release connection for easy monitor relocation or upgrade
- > Arm conceals behind the monitor and hides cables
- > Meets VESA mounting standards for 2 15/16" and 3 15/16" monitor mounting
- > 3-in-1 mount system; clamp, bolt-thru or grommet mounts



## CLU II FOR SINGLE MONITORS

- > Weight capacity: 4.4–15.4 lbs.
- > W x H: 18 9/16" x 22 1/16"

**Material**  
Aluminum

Finish	Item No.
black	818.45.300
silver	818.45.900



## CLU DUO FOR DUAL MONITORS

- > Weight capacity for each arm: 4.4–15.4 lbs.
- > W x H: 14 7/8" x 19 5/8"

**Material**  
Aluminum

Finish	Item No.
black	818.45.310
silver	818.45.910

# FILE FRAME KITS AND VOLANTE DESKTOP



## FILE FRAME KITS

- > Letter Width File Drawer Requirements:  
Inside width greater than 12"; Inside depth less than 23"
- > Legal Width File Drawer Requirements:  
Inside width greater than 15"; Inside depth less than 23"

### Material/Finish

Steel/Plastic, black

Size	Item No.
Letter width	422.74.310
Legal width	422.74.320

### Supplied With

- 2 Fixed front rails
- 2 Cut-to-size side rails
- 2 Attachment brackets
- Divider



## SIT TO STAND WORKSTATION

- > Ships fully assembled for easy install
- > The compact footprint easily fits onto a 24" deep desk
- > Primary work surface is large enough to accommodate two x 24" monitors
- > Large keyboard surface easily holds a keyboard and mouse
- > At full elevation primary work surface is positioned 20" above desk
- > Supports 35 lbs. of technology
- > The keyboard surface can be adjusted through 20° (-10+10)
- > Weighs less than 40 lbs. for one person installation
- > Side mounted paddles control gas assist height adjustment
- > Keyboard surface adjusts with the primary surface

### Material

Steel/Phenolic

Finish	Item No.
black	633.44.000

# HANGING FILE SYSTEM

- > Simple, flexible solution for mounting into any file drawer
- > No cutting or grooving required to install
- > Flush mount or top mount to drawer side, front, or back
- > Accepts 1/8" file bar

## BRACKETS

- > Flush mount; screw mounted

### Material

Steel, 16 gauge



Finish	Item No.
zinc-plated	424.31.900
black oxide	424.31.300

## BRACKETS

- > Top mount; screw mounted

### Material

Steel, 16 gauge



Finish	Item No.
zinc-plated	424.31.910
black oxide	424.31.310

## CROSS RAIL

- > Fits in brackets above
- > Easily cut to length for your application
- > L x W x H: 98 1/2" x 1/8" x 7/16"

### Material

Aluminum, unfinished



Item No.
422.74.900

## RAILS

- > Snaps onto drawer sides, requiring no glue or staples
- > Add clips and cross rails to accommodate different sized drawers and file sizes
- > L x W x H: 98 1/2" x 5/16" x 7/8"



### Material

Plastic

Color	Side thickness	Item No.
black	1/2"	422.72.381
white	1/2"	422.73.790
black	5/8"	422.72.392
white	5/8"	422.73.792

## RAIL CLIP

- > Hangs over file rail (above), allowing files to be hung at 90° angle to rails



### Material

Plastic

Color	Item No.
black	422.73.300

### Supplied With

10 pcs.

# POWER AND CHARGING



## HIDE-A-DOCK WITH 1 OUTLET, 2 USB PORTS

- > Great for charging iPhones, smart phones, iPads, tablets, digital cameras and other USB chargeable devices
- > Requires approx. 4" of space under worksurface
- > 1 grounded AC outlet, 125V 12A rating
- > 5V DC 4.2 A USB charger with 2 ports
- > Cut-out dimensions (W x D): 4 7/8" x 4"



**Material**  
Aluminum

Finish	Item No.
black	822.09.330
silver	822.09.930

**Supplied With**  
10' Power cord

## HIDE-A-DOCK WITH 2 OUTLETS, 2 USB PORTS

- > Great for charging iPhones, smart phones, iPads, tablets, digital cameras and other USB chargeable devices
- > Requires approx. 4" of space under worksurface
- > 2 grounded AC outlets, 125V 12A rating
- > 5V DC 4.2A USB charger with 2 ports
- > Cut-out dimensions (W x D): 6 3/8" x 4"



**Material**  
Aluminum

Finish	Item No.
black	822.09.331
silver	822.09.931

**Supplied With**  
10' Power cord

## POP-UP USB CHARGING CENTER

- > Unique pop-up design for charging devices such as laptops, tablets, phone, cameras, MP3 players, etc.
- > With 2 USB charging ports 2.0A
- > Requires a Ø1 7/8" hole for screw mounting



**Material**  
Plastic/Metal Surface Look

Color	Item No.
silver	822.64.033

**Supplied With**  
2 m Lead with transformer  
2 m Lead from unit  
Trim Ring

## CHARGING GROMMET

- > Easily replace a standard Ø2 3/8" desktop cable grommet
- > With cable opening and removable tab to feed cables through
- > With 1-120V socket and 1-USB charging port 2.0A



**Material**  
Plastic

Color	Item No.
black	822.99.350

**Supplied With**  
Wall transformer  
10A X 1.5 m power cable and 1 m USB cable

# POWER AND CHARGING



## POP-UP POWER STATION

- > 2 AC receptacles, 120V / 60Hz
- > 2 USB 2.1A charging ports
- > Ø3" hole for installation
- > Requires 12" space under work surface

**Material**  
Plastic



Color	Item No.
black	822.99.340

**Supplied With**  
6' Power cord

**Note**  
USB ports charge through the unit's power cord.

## POP-UP POWER STATION

- > 3 outlets
- > AC 125V 12A max.
- > Ø3" hole for installation
- > Requires 12" space under work surface

**Material**  
Plastic



Color	Item No.
black	822.99.320

**Supplied With**  
6' Power cord

# POWER AND CHARGING

## QUICK CHARGING UNITS

- > With dual USB Ports
- > USB-C power delivery 3.0 offers 46 watts of power and can charge devices up to 70% faster
- > Includes a USB-A port allowing users to charge 2 units simultaneously
- > Easy to install
- > Available in grommet or edge mount versions



## GROMMET MOUNT

- > For 2"-2 3/8" through holes
- > With cable pass-through slot
- > Counter thickness: 9/16" x 2 3/16"
- > Ø x H: 2 3/4" x 3 3/16"

### Material

Plastic

Finish	Item No.
black	822.99.357
off-white	822.99.358

### Supplied With

Power adapter  
Power cord

## EDGE MOUNT

- > Mounts with adhesive tape and/or screws
- > Sliding covers protect the ports when not in use
- > W x D x H: 2 3/16" x 11/16" x 1 5/16"

### Material

Plastic

Finish	Item No.
black	822.99.355
off-white	822.99.356

### Supplied With

Power adapter  
Power cord

# POWER AND CHARGING

- > With touch release spring-loaded lid
- > 1 AC outlet: 125V 15A
- > Installs in a 3" diameter hole, tightens with the nut from below



## DOCKING STATION 250

- > With 1 USB port 5V DC 2.1A (10.5 watts) charging power
- > Ø: 3 5/8"

**Material**  
Plastic

Finish	Item No.
black	822.99.330
white	822.09.304

**Supplied With**  
10' 14AWGx3C power cord



## DOCKING STATION 270

- > Fast charging with 2 USB ports 5V DC 4.2A (21 watts) of charging power
- > Ø: 3 5/8"

**Material**  
Plastic

Finish	Item No.
black	822.09.305
white	822.09.306

**Supplied With**  
10' 14AWGx3C power cord



## DOCKING STATION 271

- > Without lid
- > Fast charging with 2 USB ports 5V DC 4.2A (21 watts) of charging power
- > 1 AC outlet: 125V 15A
- > Ø: 3 5/8"

**Material**  
Plastic

Finish	Item No.
black	822.09.307
white	822.09.308

**Supplied With**  
10' 14AWGx3C power cord



# POWER AND CHARGING

## DOCKING DRAWER BLADE 15 AMP SERIES



### DOCKING DRAWER BLADE

> With 2 x AC outlets and 2 x USB-A ports

**Material**

Metal with Plastic and Electrical Components

Finish	Model	Item No.
black	1514-110B	822.53.359
white	1514-110W	822.53.360
stainless steel	1514-110S	822.53.361

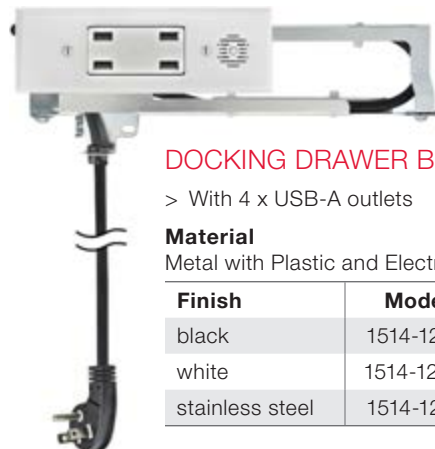

### DOCKING DRAWER BLADE

> With 4 x USB-A outlets

**Material**

Metal with Plastic and Electrical Components

Finish	Model	Item No.
black	1514-120B	822.53.362
white	1514-120W	822.53.363
stainless steel	1514-120S	822.53.364

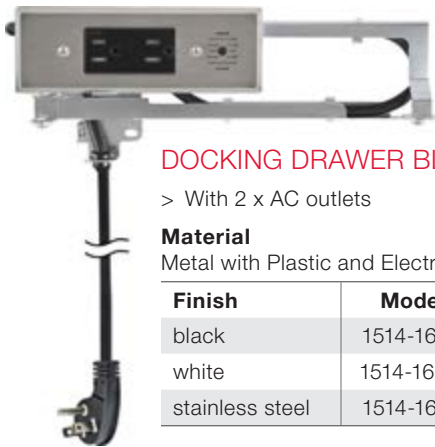

### DOCKING DRAWER BLADE

> With 2 x AC outlets

**Material**

Metal with Plastic and Electrical Components

Finish	Model	Item No.
black	1514-160B	822.53.371
white	1514-160W	822.53.372
stainless steel	1514-160S	822.53.373

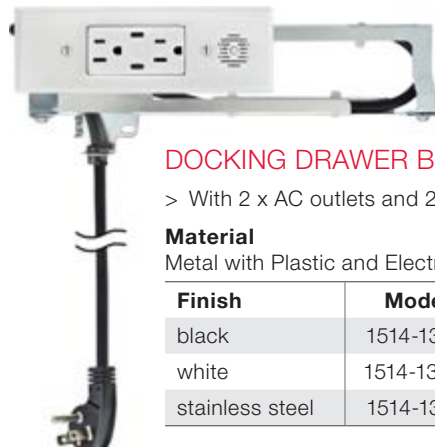

### DOCKING DRAWER BLADE

> With 2 x AC outlets and 2 x USB-C (PD) ports

**Material**

Metal with Plastic and Electrical Components

Finish	Model	Item No.
black	1514-130B	822.53.365
white	1514-130W	822.53.366
stainless steel	1514-130S	822.53.367

# CABLE MANAGEMENT



## CABLE GROMMETS, TWO-PIECE, ROUND

- > With removable top
- > Thin design, can be used with 5/8" thick panels
- > For press-fitting into 2 1/2" holes

### Material

Plastic

Color	Item No.
bronze	631.26.111
dark brown	631.26.112
black	631.26.311
almond	631.26.411
ivory	631.26.412
gray	631.26.511
stone	631.26.512
candlelight	631.26.611
white	631.26.711



## CABLE SETS, TWO-PIECE, ROUND

- > With spring closure
- > For press-fitting or gluing

### Material

Plastic

Color	Ø2"	Ø2 3/8"	Ø3 1/8"
white	429.99.735	429.99.726	429.99.744
light gray	429.99.539	429.99.520	429.99.548
beige	429.99.431	429.99.422	429.99.440
almond	429.99.039	429.99.020	429.99.048
brown	429.99.137	429.99.128	429.99.146
black	429.99.333	429.99.324	429.99.342
chrome matt	429.97.222	429.97.231	429.97.240
brass matt	429.97.526	-	-



## GROMMETS WITH BRUSH

### Material

Plastic

Color	Item No.
stainless steel color	631.35.014
silver/aluminum RAL 9006	631.35.214
black	631.35.314



## CABLE GUIDES, SPIRAL DESIGN

- > Flexible, for use with different table heights, especially height adjustable tables
- > With weighted base
- > Screw mounts under table
- > Table height: max. 47"

### Material

Plastic

Color	Item No.
black	631.20.310
silver colored	631.20.910
white	631.20.710

# WIRE MANAGEMENT



## WIRE MANAGEMENT TRAYS

- > Use under work surfaces to manage wires
- > Solid yet lightweight aluminum construction
- > Includes larger entry/exit holes evenly spaced for larger plugs
- > Screw mounted
- > W x H: 3 1/2" x 2 1/2"

**Material**  
Aluminum

Length	Color	Item No.
20"	black	631.03.340
20"	white	631.03.740
44"	black	631.03.341
44"	white	631.03.741

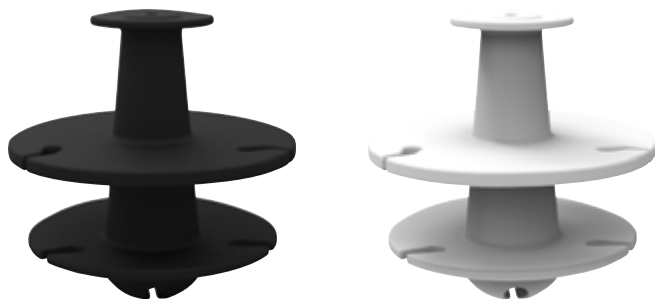

## DOUBLE-DECK WIRE MANAGEMENT REELS

- > Use under work surfaces to manage wires
- > Double deck reel to separate cords
- > Screw mounted
- > W x H: 3 1/2" x 3 1/2"

**Material**  
TPR-Thermo Plastic Rubber

Finish	Item No.
black	631.39.320
white	631.39.720



## CABLE GRIP

- > Cables are securely gripped when inserted between loops
- > Screw mounted
- > L x W x H: 3 5/8" x 2 5/8" x 1 5/8"

**Material**  
Plastic

Color	Item No.
black	631.39.310

# TABLE LEGS



## E-LEGS Ø60 MM

- > Adjustment range: 1"
- > Static weight rating: approximately 220 lbs. per leg

### Material

Steel, plated or epoxy-coated  
Mounting plate & Leveler: Plastic, black

Height	Finish	Item No.
28"	polished chrome	635.61.276
	black semi-gloss	635.61.376
	black textured	635.61.378
	satin nickel	635.61.476
	silver aluminum RAL 9006	635.61.977
34 1/2"	polished chrome	635.61.295
	black semi-gloss	635.61.395
	black textured	635.61.397
	satin nickel	635.61.496
	silver aluminum RAL 9006	635.61.996

### Supplied With

- 4 Legs
- 4 Mounting plates
- 4 Levelers
- Screws #9 x 1"

### Note

Heights listed includes mounting plate and leveler.



## HAIR PIN LEGS

- > A selection of vintage hair pin style feet and legs
- > Static weight rating: approximately 110 lbs. per leg
- > Mounting plate W x D: 2" x 4 3/4"

### Material

Steel, powder-coated

Height	matt black	moss gray	pearl gold
7 7/8"	634.46.030	634.46.040	634.46.035
15 3/4"	634.46.031	634.46.041	634.46.036
28"	634.46.032	634.46.042	634.46.037

### Supplied With

- 4 Legs

### Note

Optional floor protectors are available, please order separately.

## FLOOR PROTECTORS

- > Snap onto hair pin legs
- > Ø: 1 1/4"

### Material

Plastic

Color	Item No.
black	634.46.090

### Supplied With

- 4 pcs.



# ESSENTIAL 2

## ELECTRIC ADJUSTABLE TABLE BASE WITH COLLISION MITIGATION SENSOR

The Essential 2 table base system is the ultimate cost effective adjustable table system. German engineered and assembled in the USA. Essential 2 now features a Gyro Sensor which ensures protection in the event of a collision during the stroke of the table.

- > Maximum weight capacity: 250 lbs. including weight of top
- > Recommended for top widths: 48"-72"
- > Simple assembly
- > Height range: 26"-45" = 19" stroke
- > Speed: 1.375" per second
- > Power consumption: <0.3W
- > Noise level: < 50DB
- > Meets BIFMA X5.5 standards
- > UL 962 approved
- > Available in Black, Silver or White
- > Choose from simple Up/Down switch or 4-Setting programmable switch
- > Anti-sag bar recommended for tops over 61" wide



**Note**

Weight rating is based on: An evenly distributed load over table top.  
Table base constructed using specified components; columns, feet and top supports.

Please provide at least 1" space between table top and any adjoining surfaces, cabinets, etc.



### ESSENTIAL 2 BASES

Version	Finish	Item No.
With simple up/down switch	black	630.46.390
	silver	630.46.391
	white	630.46.392
With 4-setting programmable switch	black	630.46.393
	silver	630.46.394
	white	630.46.395

**Supplied With**

- 2 Adjustable columns
- Control box
- Switch
- Cables
- Assembly hardware

### ANTI-SAG BAR, OPTIONAL

- > For tops over 61" wide to keep top from sagging

Finish	Item No.
black	630.46.382

**Supplied With**

- Wood screws

# HÄFELE FREE SPACE

- > Free Space can be used for up to 80% of all flap applications
- > For wood or aluminum frame doors
- > Extremely compact: modern design and Häfele engineered technology allow for more space inside a cabinet
- > Intuitive 3D door alignment and closing adjustment
- > Additional hinges and cover caps are not required

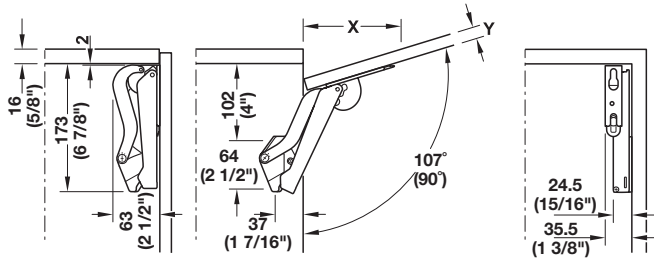

Front panel thickness Y	5/8"	3/4"	7/8"	1"
Distance X (with cabinet top panel thickness 5/8")	4 5/8"	4 1/4"	3 7/8"	3 1/4"

**Note**

Dim X helps calculate space required when raised panels or crown moldings are used.

## FREE SPACE 1.11

- > For standard applications with handle
- > For front height: < 26"
- > Height/side/tilting angle and holding power
- > Screw mounts with pre-mounted Euro screw, front panel mounts without tools or slides onto pre-mounted screws
- > Max. door overlay: 90° opening: 1 1/4"; 107° opening: 7/8"

**Material**

Housing: Plastic; Mounting Bracket and Support Lever: Steel  
Finish: nickel-plated

Model	light gray	white	anthracite
B	372.27.500	372.27.700	372.27.350
C	372.27.501	372.27.701	372.27.351
D	372.27.502	372.27.702	372.27.352
E	372.27.503	372.27.703	372.27.353
F	372.27.504	372.27.704	372.27.354

**Supplied With**

- 2 Fittings (right/left)
- 4 Mounting screws for front panel
- 1 Set mounting instructions and drilling template

**Note**

The choice of fitting depends on the cabinet height and door weight to include weight of handle.

## SCREW FOR ALUMINUM FRAME DOORS

- > For connecting aluminum frame front panels with frame widths from 1 3/4"



**Material**

Steel

Finish	Item No.
nickel-plated	372.27.600

**Supplied With**

- 4 screws and collar rings



Measurements table for selecting the right model based on cabinet height and door weight including weight of handle. We recommend ordering the stronger fitting model if in doubt.

Model	Door Weight Ranges in Pounds									
	B		C		D		E		F	
Door Height	Min	Max	Min	Max	Min	Max	Min	Max	Min	Max
9"	5.1	9.5	8.4	15.6	14.1	20.5	20.2	29.5	29.5	42.0
10"	4.2	8.6	7.5	14.1	12.8	20.0	18.3	27.7	26.6	37.8
11"	4.2	7.7	6.8	12.8	11.7	18.0	16.5	26.4	24.2	34.3
12"	3.7	7.0	6.2	11.7	10.6	16.5	15.2	24.2	22.2	31.5
13"	3.5	6.6	5.7	10.8	9.7	15.4	14.1	22.4	20.5	29.0
14"	3.3	6.2	5.3	10.1	9.0	14.3	13.0	20.9	18.9	27.1
15"	2.9	5.7	4.8	9.5	8.4	13.2	12.1	19.4	17.8	25.1
16"	2.6	5.3	4.6	8.8	7.9	12.3	11.4	18.3	16.7	23.5
17"	2.4	5.1	4.4	8.4	7.5	11.7	10.8	17.2	15.6	22.2
18"	2.2	4.6	4.2	7.7	7.0	11.0	10.1	16.1	14.7	20.9
19"	2.2	4.4	4.0	7.5	6.6	10.3	9.5	15.4	14.1	19.8
20"	2.0	4.2	3.7	7.0	6.4	9.9	9.0	14.5	13.2	18.9
21"	2.0	4.0	3.5	6.6	5.9	9.5	8.6	13.9	12.5	18.0
22"	1.8	3.7	3.3	6.4	5.7	9.0	8.1	13.2	12.1	17.2
23"	1.8	3.7	3.1	6.2	5.5	8.6	7.9	12.5	11.4	16.3
24"	1.8	3.5	3.1	5.9	5.3	8.1	7.5	12.1	11.0	15.6
25"	1.5	3.3	2.9	5.5	5.1	7.9	7.3	11.7	10.6	15.0
26"	1.5	3.3	2.9	5.3	4.8	7.7	7.0	11.2	10.1	14.5

Order suitable screw set for aluminum frame doors, to the right.

## FREE SPACE DRILLING JIG

- > For pilot drilling the cabinet side panels and door panel

**Material**

Plastic; Drilling Sleeves: Steel

Finish	Item No.
nickel-plated	372.27.602

**Note**

For drilling patterns, please see Free Space installation instructions.

# SHELVING

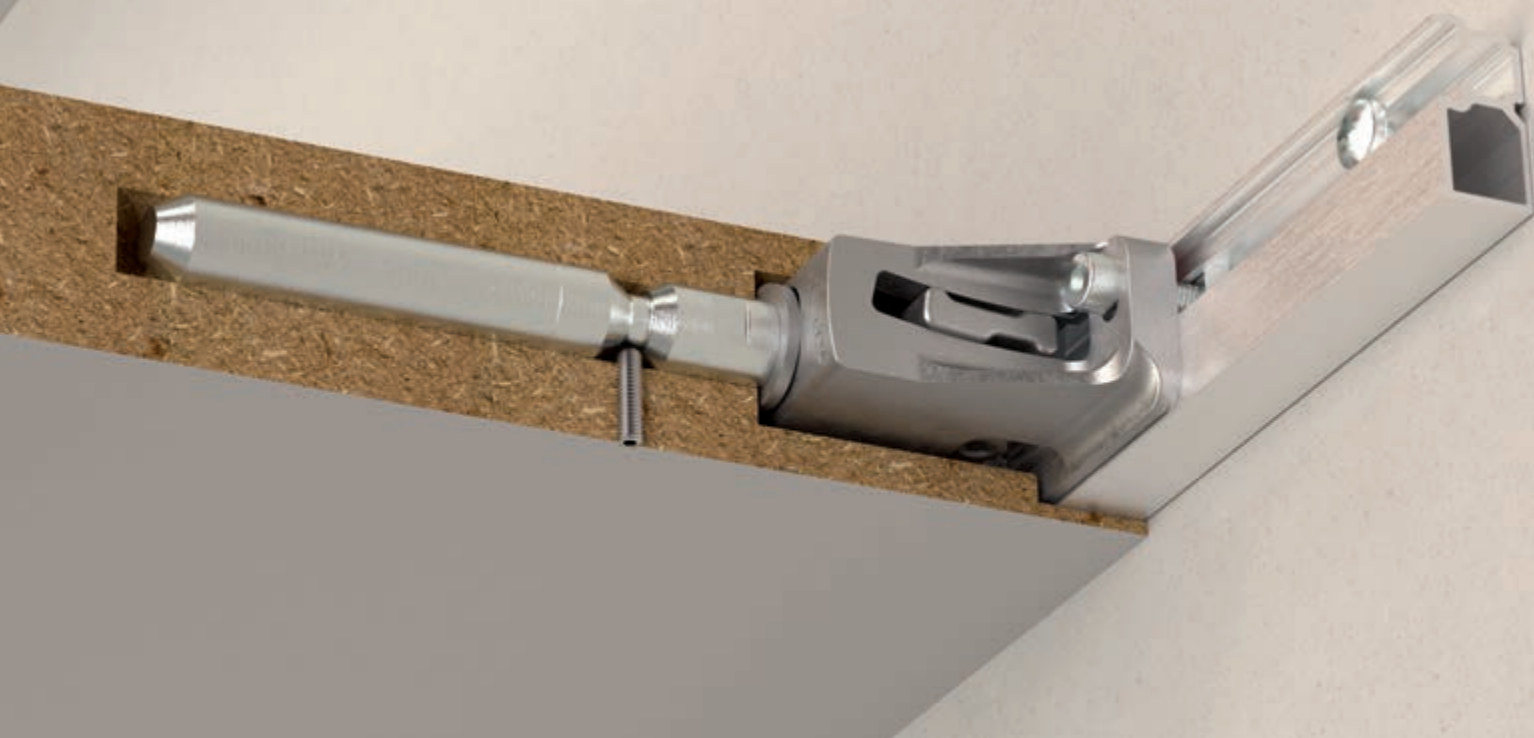

Ah, shelving. The original open storage solution. Simple, yet eternally useful. Shelving options from Häfele range from the durable, utilitarian standards and brackets to the stylishly tasteful glass shelf supports – and everything in-between. A must for many projects these days – from entertainment centers to pantries – are our concealed options for floating shelves.

# SHOPTEC

- > Heavy duty
- > Double slot design
- > Adjustable in 1" increments
- > ANSI/BHMA 156.9-2003 Grade 2 Compliant
- > Weight capacity: max. 425 lbs./pair

## PREMIUM DOUBLE STANDARDS

- > 14 gauge steel
- > W x D: 1 1/16" x 11/16"

**Material/Finish**  
Steel, white

Length	Item No.
16 1/2"	774.10.640
28"	774.10.642
39"	774.10.644
48"	774.10.645
63"	774.10.647
78"	774.10.649
94"	774.10.651



## DOUBLE STANDARDS

- > 16 gauge steel
- > W x D: 1 1/4" x 1/2"

**Material/Finish**  
Steel, zinc-plated

Length	Item No.
24"	774.10.621
36"	774.10.623
48"	774.10.625
60"	774.10.626
72"	774.10.628
84"	774.10.630
96"	774.10.632



## PREMIUM BRACKETS

- > 14 gauge steel
- > Double lug design provides secure support

**Material/Finish**  
Steel, white



Length	D	Item No.
10 1/2"	1 7/16"	774.11.645
12 1/2"	1 7/16"	774.11.647
14 1/2"	2 1/2"	774.11.649
18 1/2"	1 3/4"	774.11.652
24 1/2"	1 5/8"	774.11.656

## BRACKETS

- > 16 gauge steel
- > Double lug design provides secure support

**Material/Finish**  
Steel, zinc-plated



Length	Item No.
8"	774.11.622
10"	774.11.624
12"	774.11.626
14"	774.11.629
16"	774.11.630
18"	774.11.631
20"	774.11.633
22"	774.11.634
24"	774.11.635



# SHELF SUPPORTS

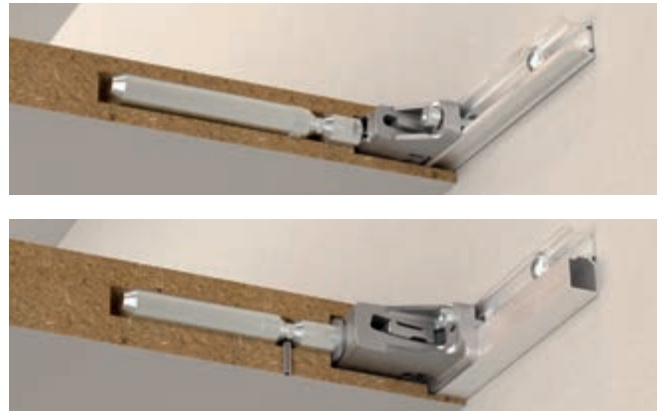

## TRIADE MAXI SHELF SUPPORT



- > Concealed mounting for floating shelf
- > For material thickness: 40 mm
- > Inclination adjustment: -8–20 mm via 10 mm spanner  
Height adjustment: +/- 2.5 mm via slotted plate  
Side adjustment: +/- 2.5 mm via locking screw
- > Weight capacity: 44 lbs. per support for 200–400 mm shelf depth

**Material**  
Zinc/Steel

	Item No.
	283.39.030

## TRIADE MAXI SHELF SUPPORT BRACKET



- > Provides extra support to TRIADE shelf supports by providing 3 fixing points via Ø8 mm pin and screw fix

**Material**  
Steel

Finish	Item No.
zinc-plated	283.39.021

**Supplied With**  
M5 x 12 mm screws

## TRIADE MAXI ALUMINUM PROFILE



- > Optional solution for mounting on drywall surfaces with framework
- > Use with TRIADE supports
- > Can be cut and drilled
- > Attaches to framework with #10 Pan head screw
- > Length: 2400 mm

**Material**  
Aluminum



	Item No.
	283.39.031

## HARDWARE FOR TRIADE SHELF SUPPORTS

- > For attaching any TRIADE shelf support to aluminum profile

**Material**  
Steel

	Item No.
	283.39.032

**Supplied With**  
4 - M5 x 20 mm screws  
4 - M5 square nuts

# SHELF SUPPORTS

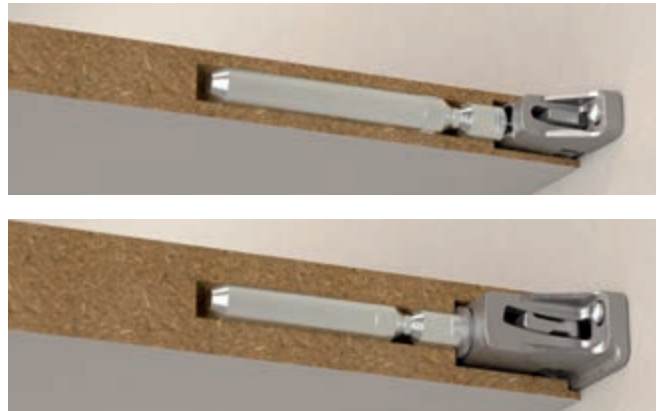

## TRIADE MINI SHELF SUPPORT



- > Concealed mounting for floating shelf
- > For material thickness: 25–30 mm
- > Inclination adjustment: -6 to 13 mm via 10 mm spanner
- Height adjustment: +/- 2.5 mm via slotted plate
- Side adjustment: +/- 2.5 mm via locking screw
- > Weight capacity: 9.9 lbs. per support for 165–200 mm shelf depth

**Material**

Zinc/Steel

Item No.
283.39.011

## TRIADE MINI SHELF SUPPORT BRACKET



- > Provides extra support to TRIADE shelf supports by providing 3 fixing points via Ø8 mm pin and screw fix

**Material**

Steel

Finish	Item No.
zinc-plated	283.39.022

**Supplied With**

M5 x 12 mm screws

## TRIADE SHELF SUPPORT



- > Concealed mounting for floating shelf
- > For material thickness: 30–40 mm
- > Inclination adjustment: -6 to 13 mm via 10 mm spanner
- Height adjustment: +/- 2.5 mm via slotted plate
- Side adjustment: +/- 2.5 mm via locking screw
- > Weight capacity: 33 lbs. per support for 165–300 mm shelf depth

**Material**

Zinc/Steel

Item No.
283.39.010

## TRIADE SHELF SUPPORT BRACKET



- > Provides extra support to TRIADE shelf supports by providing 3 fixing points via Ø8 mm pin and screw fix

**Material**

Steel

Finish	Item No.
zinc-plated	283.39.019

**Supplied With**

M5 x 12 mm screws

## TRIADE/TRIADE MINI ALUMINUM PROFILE

- > Length: 2400 mm

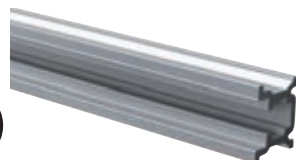

**Material**

Aluminum

Item No.
283.39.030

## HARDWARE FOR TRIADE SHELF SUPPORTS

- > For attaching any TRIADE shelf support to aluminum profile

**Material**

Steel

Item No.
283.39.032

**Supplied With**

- 4 - M5 x 20 mm screws
- 4 - M5 square nuts

# SHELF SUPPORTS

- > Distance between supports: max. 27 9/16"
- > With assembly instructions
- > For wall thickness 1/16"
- > Weight capacity: up to 187 lbs. per m<sup>2</sup> by evenly distributed loading on the shelf



## SUPPORT FOR GLASS SHELVES

**Material**

Stainless Steel/Plastic/Rubber

**Finish**

matt, brushed, black

**Item No.**

283.38.020

**Supplied With**

Support - Ø20 mm, Base, 2 o-rings

Countersunk screw M6 x 60 mm

Wall anchor

**Note**

2 sets needed for one shelf.

## DECORATIVE HARDWARE



Decorative hardware is the ultimate finishing touch for any project. It can add personality and function to any manner of cabinetry, pull-outs, drawers and doors. Häfele's selection runs the gamut when it comes to style. We offer entire collections which match perfectly in finish with our TAG Hardware closet components as well as many other traditional, transitional and contemporary options to meet your project needs.

# TRANSITIONAL HANDLES AND KNOBS

**Note**

\* Indicates finish shown.

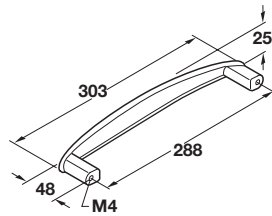

**Material**  
Zinc

Finish	Item No.
stainless steel look*	110.18.057
oil-rubbed bronze	110.18.357

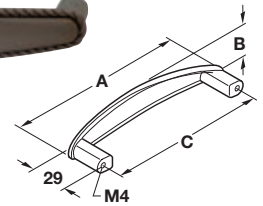

**Material**  
Zinc

Finish	A	B	C	Item No.
stainless steel look	111	15	96	125.68.051
stainless steel look	140	18	128	125.68.052
oil-rubbed bronze	111	15	96	125.68.351
oil-rubbed bronze*	140	18	128	125.68.352

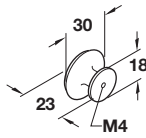
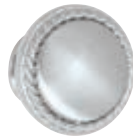

**Material**  
Zinc

Finish	Item No.
stainless steel look*	133.79.051
oil-rubbed bronze	133.79.351

Dimensions in mm unless otherwise noted.

# TRANSITIONAL HANDLES

**Note**

\* Indicates finish shown.

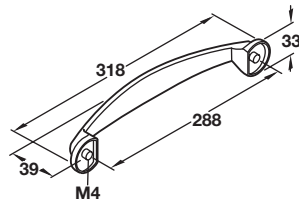

**Material**  
Zinc

Finish	Item No.
stainless steel look	107.18.618
oil-rubbed bronze*	107.18.358

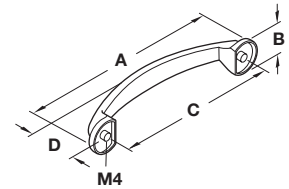

**Material**  
Zinc

Finish	A	B	C	D	Item No.
stainless steel look	115	19	96	24	107.18.612
stainless steel look*	152	24	128	29	107.18.613
oil-rubbed bronze	115	19	96	24	107.18.352
oil-rubbed bronze	152	24	128	29	107.18.353

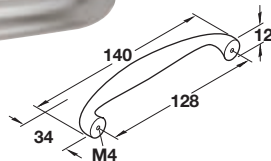

**Material**  
Zinc

Finish	Item No.
matt nickel	104.35.600

Dimensions in mm unless otherwise noted.

# MODERN HANDLES

**Note**

\* Indicates finish shown.

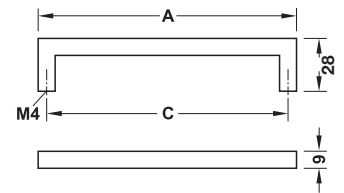

**Material**  
Zinc

Finish	A	C	Item No.
polished chrome*	105	96	155.00.040
polished chrome	137	128	155.00.041
stainless steel look	105	96	155.00.060
stainless steel look	137	128	155.00.061



**Material**  
Zinc

Finish	A	C	Item No.
matt black*	105	96	155.01.610
matt black	137	128	155.01.611
brushed brass	105	96	155.01.620
brushed brass	137	128	155.01.621



**Material**  
Zinc

Finish	A	C	Item No.
polished chrome	201	192	155.00.071
polished chrome	233	224	155.00.072
stainless steel look*	201	192	155.00.091
stainless steel look	233	224	155.00.092



**Material**  
Zinc

Finish	A	C	Item No.
matt black	201	192	155.01.612
matt black	233	224	155.01.613
brushed brass*	201	192	155.01.622
brushed brass	233	224	155.01.623

Dimensions in mm unless otherwise noted.

# ART DECO/GLAM HANDLES AND KNOBS

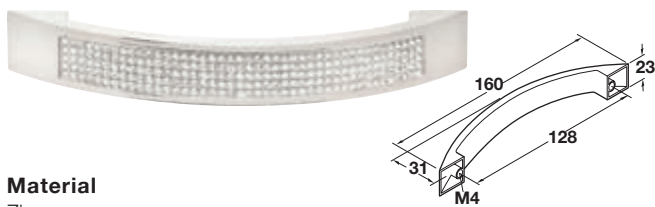
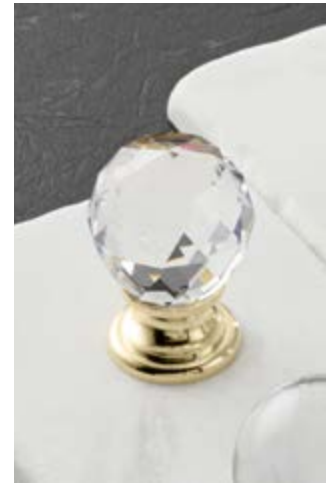

**Material**  
Zinc

Finish	Item No.
polished chrome, crystal elements	111.25.262

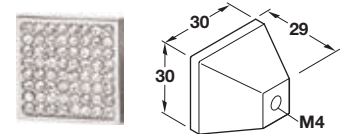

**Material**  
Zinc

Finish	Item No.
polished chrome, crystal elements	111.25.252



**Material**  
Crystal/Zinc

Finish	Item No.
polished/gold colored, polished	138.72.800
polished/polished chrome	139.60.422

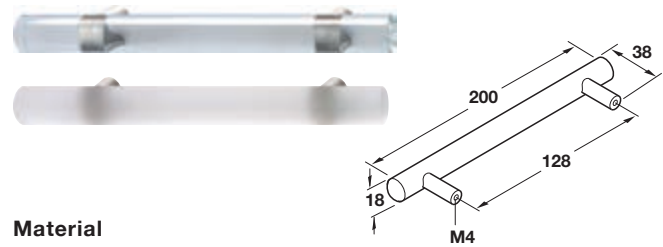

**Material**  
Glass/Stainless Steel

Finish	Item No.
clear/matt	103.79.401
frosted/matt	103.79.411

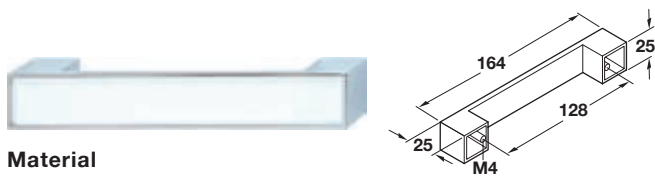

**Material**  
Zinc/Glass

Finish	Item No.
chrome polished/white	109.50.274

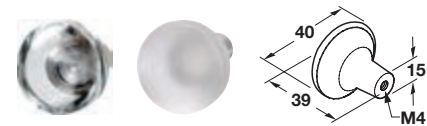

**Material**  
Glass/Stainless Steel

Finish	Item No.
clear/matt	135.73.400
frosted/matt	135.73.410

Dimensions in mm unless otherwise noted.



# CONTEMPORARY BAR PULLS

**Note**

\* Indicates finish shown.

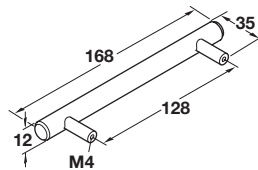

**Material**  
Steel

Finish	Item No.
brushed nickel*	155.99.016
polished chrome	155.99.014
oil-rubbed bronze	155.99.013
matt chrome	155.99.015
matt black	155.99.017
matt gold	155.02.413

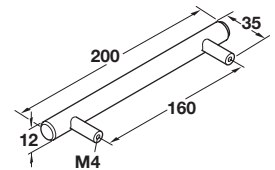

**Material**  
Steel

Finish	Item No.
brushed nickel	155.99.007
polished chrome	155.99.005
oil-rubbed bronze*	155.00.764
matt chrome	155.99.006
matt black	155.99.008
matt gold	155.02.414



**Material/Finish**

Steel, oil-rubbed bronze

A	C	Item No.
136	96	117.97.351
168	128	117.97.352
226	156	117.97.357
376	306	117.97.358
526	456	117.97.359

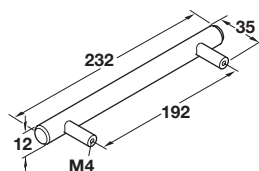
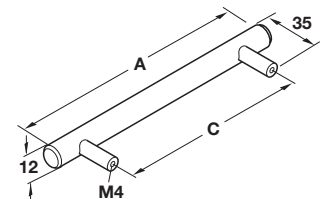

**Material**  
Steel

Finish	Item No.
oil-rubbed bronze	155.00.765
polished chrome*	155.99.009
brushed nickel	155.99.011
matt chrome	155.99.010
matt black	155.99.012
matt gold	155.02.415

Dimensions in mm unless otherwise noted.

# CONTEMPORARY BAR PULLS

**Note**

\* Indicates finish shown.

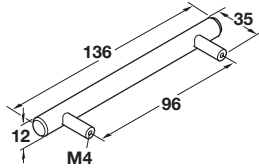

**Material**  
Steel

Finish	Item No.
oil-rubbed bronze	155.99.004
matt chrome*	155.99.001
brushed nickel	155.99.000
polished chrome	155.99.003
matt black	155.99.002
matt gold	155.02.411

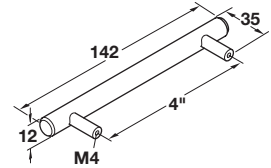

**Material**  
Steel

Finish	Item No.
brushed nickel*	155.00.801
polished chrome	155.02.421
oil-rubbed bronze	155.00.766
matt chrome	155.00.696
matt black	155.01.669
matt gold	155.02.412

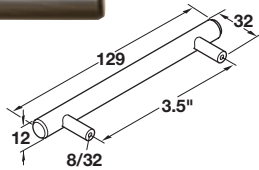

**Material**  
Steel

Finish	Item No.
brushed nickel	155.00.721
polished chrome	155.02.420
matt chrome	155.00.697
oil-rubbed bronze*	155.00.751
matt black	155.01.668
matt gold	155.02.410

Dimensions in mm unless otherwise noted.

# CONTEMPORARY BAR PULLS



**Material/Finish**

Steel, stainless steel look

A	C	Item No.
136	96	155.00.780
168	128	155.00.781
226	156	155.00.783
326	256	155.00.787
376	306	155.00.789
526	456	155.00.795

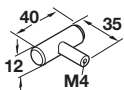
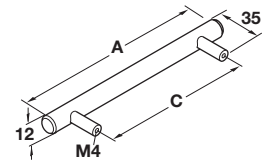

**Material**

Steel

Finish	Item No.
stainless steel look	131.33.700



**Material/Finish**

Steel, polished chrome

A	C	Item No.
226	156	155.00.810
376	306	155.00.811

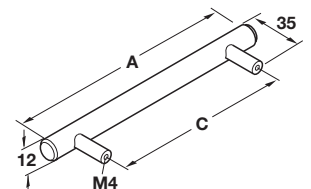

**Material**

Stainless Steel Grade 304, matt

A	C	Item No.
146	96	117.05.600
178	128	117.05.610
242	192	117.05.620
370	320	117.05.640

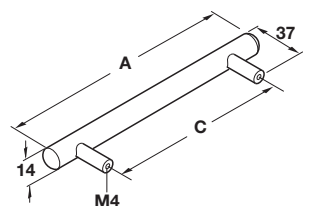

Dimensions in mm unless otherwise noted.

# CONTEMPORARY HANDLES AND KNOBS

**Note**

\* Indicates finishes shown in order.

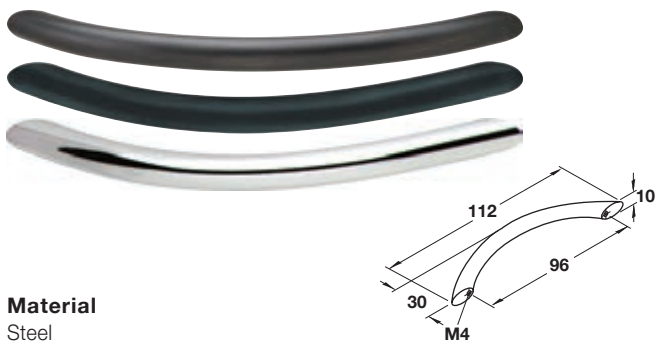

**Material**

Steel

Finish	Item No.
oil-rubbed bronze	155.99.020
dark oil-rubbed bronze*	155.00.870
black matt*	155.99.019
polished chrome*	155.99.018
matt nickel	155.00.840
matt chrome	155.99.021
matt gold	155.99.032
brushed nickel	155.99.022

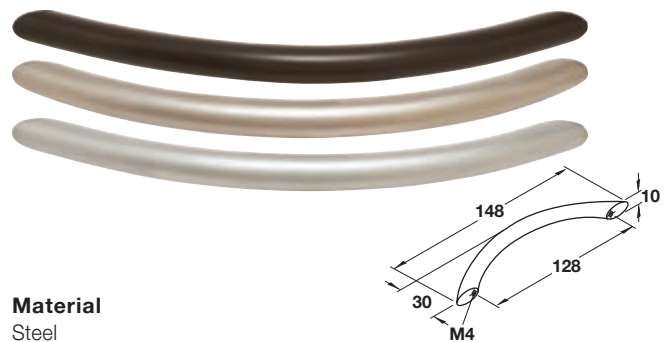

**Material**

Steel

Finish	Item No.
oil-rubbed bronze*	155.99.025
black matt	155.99.024
polished chrome	155.99.023
dark oil-rubbed bronze	155.00.871
matt nickel*	155.00.841
matt chrome*	155.99.026
matt gold	155.02.430
brushed nickel	155.99.027



**Material**

Zinc

Finish	Item No.
matt nickel*	134.06.641
satin chrome*	134.06.441
oil-rubbed bronze	155.01.818
black matt	155.99.028
brushed nickel	155.99.029
polished chrome*	155.99.030
dark oil-rubbed bronze*	134.06.311
matt chrome	155.99.031
matt gold	155.01.819

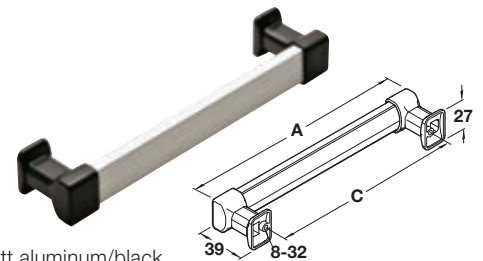

**Material/Finish**

Aluminum/Zinc, matt aluminum/black

A	C	Item No.
188	160	111.95.063
412	384	111.95.069

Dimensions in mm unless otherwise noted.

# CONTEMPORARY HANDLES

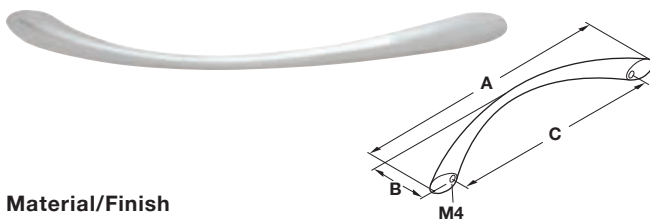

**Material/Finish**  
Zinc, stainless steel look

A	B	C	Item No.
113	24	96	155.00.491
158	29	128	155.00.492



**Material/Finish**  
Zinc, stainless steel look

A	B	C	Item No.
142	16	96	155.00.440
183	17	128	155.00.441

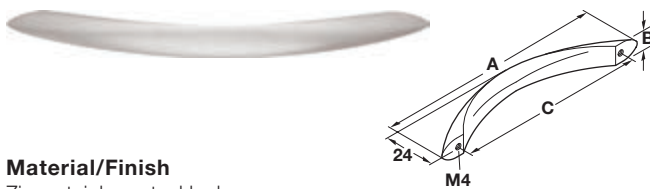

**Material/Finish**  
Zinc, stainless steel look

A	B	C	Item No.
127	12	96	155.00.600
160	13	128	155.00.601

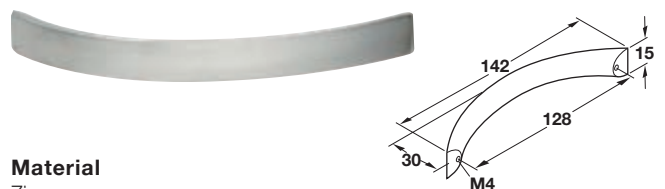

**Material**  
Zinc

Finish	Item No.
stainless steel look	104.08.000



**Material**  
Zinc

Finish	Item No.
stainless steel look	102.47.953

Dimensions in mm unless otherwise noted.

# MINIMALIST/ ARCHITECTURAL HANDLES

**Note**

\* Indicates finishes shown in order.

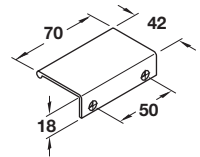
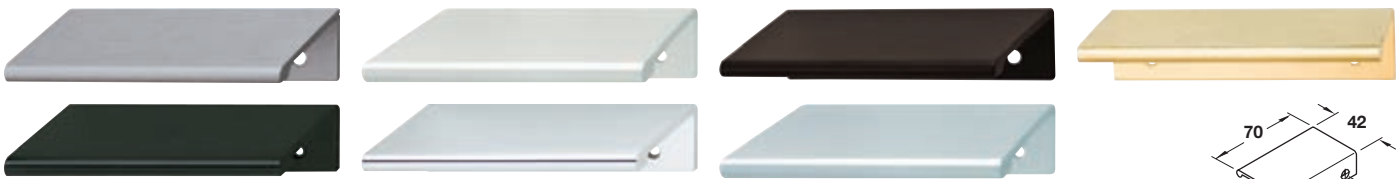

**Material**

Aluminum

**Finish**

satin aluminum\*

polished black\*

matt aluminum\*

polished chrome\*

dark oil-rubbed bronze\*

silver anodized\*

brushed brass\*

**Item No.**

124.02.432

124.02.320

124.02.921

124.02.220

124.02.332

124.02.920

124.02.501

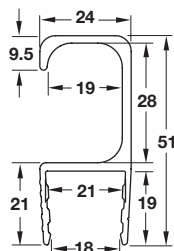

**Material/Finish**

Aluminum, matt aluminum

**Length**

2500 mm

**Item No.**

792.01.060

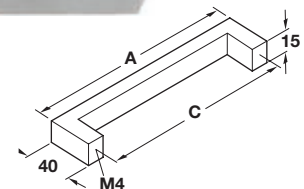

**Material/Finish**

Stainless Steel Grade 304, matt

**A**

143

243

**C**

128

228

**Item No.**

100.45.051

100.45.055

Dimensions in mm unless otherwise noted.

# TAG MID-CENTURY MODERN

**Note**

Finishes match and are ideal for use with Synergy, Synergy Elite, Engage and Signature closet accessories. Supplied with 1" screws.  
\* Indicates finish shown.



**Material**  
Zinc

Finish	Item No.
polished chrome	111.95.150
matt aluminum	111.95.151
matt nickel	111.95.152
black*	111.95.309
matt gold	111.95.154
slate/graphite	111.95.155



**Material**  
Zinc

Finish	Item No.
polished chrome	111.95.140
matt aluminum	111.95.141
matt nickel*	111.95.142
black	111.95.300
matt gold	111.95.144
slate/graphite	111.95.145



**Material**  
Zinc

Finish	Item No.
polished chrome	111.95.130
matt aluminum	111.95.131
matt nickel	111.95.132
black	111.95.308
matt gold*	111.95.134
slate/graphite	111.95.135



**Material**  
Zinc

Finish	Item No.
polished chrome	111.95.170
matt aluminum*	111.95.171
matt nickel	111.95.172
black	111.95.302
matt gold	111.95.174
slate/graphite	111.95.175



**Material**  
Zinc

Finish	Item No.
polished chrome	111.95.180
matt aluminum	111.95.181
matt nickel	111.95.182
black*	111.95.310
matt gold	111.95.184
slate/graphite	111.95.185

Dimensions in mm unless otherwise noted.

# TAG MID-CENTURY MODERN

**Note**

TAG finishes match and are ideal for use with Synergy, Synergy Elite, Engage and Signature closet accessories. See the Closet and Home Solutions catalog. Supplied with 1" mounting screws.

\* Indicates finish shown.

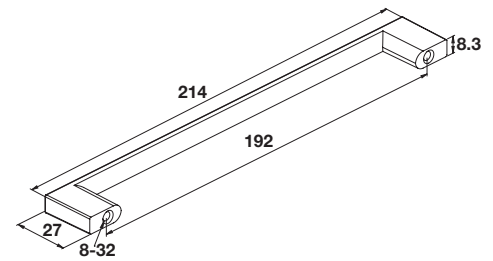

**Material**  
Zinc

Finish	Item No.
black	111.95.307
matt gold*	111.95.282
slate/graphite	111.95.285
matt aluminum	111.95.281
polished chrome	111.95.280
matt nickel	111.95.283

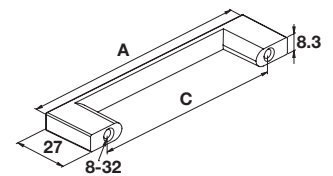

**Material**  
Zinc

Finish	A	C	Item No.
black	150	128	111.95.306
matt gold	150	128	111.95.272
slate/graphite*	150	128	111.95.275
matt aluminum	150	128	111.95.271
polished chrome	150	128	111.95.270
matt nickel	150	128	111.95.273
black	118	96	111.95.305
matt gold	118	96	111.95.262
slate/graphite	118	96	111.95.265
matt aluminum	118	96	111.95.261
polished chrome	118	96	111.95.260
matt nickel	118	96	111.95.263

Dimensions in mm unless otherwise noted.



# TAG MODERN

**Note**

Finishes match and are ideal for use with Synergy, Synergy Elite, Engage and Signature closet accessories. Supplied with 1" screws.  
 \* Indicates finish shown.

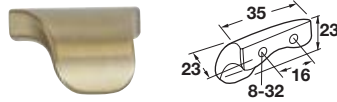

**Material**  
Zinc

Finish	Item No.
polished chrome	111.95.160
matt aluminum	111.95.161
matt nickel	111.95.162
black	111.95.301
matt gold*	111.95.164
slate/graphite	111.95.165

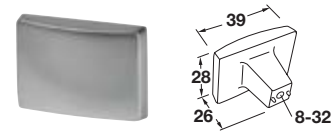

**Material**  
Zinc

Finish	Item No.
polished chrome	111.95.000
matt aluminum*	111.95.001
matt nickel	111.95.004
black	111.95.303
matt gold	111.95.003
slate/graphite	111.95.005



**Material**  
Zinc

Finish	Item No.
polished chrome*	111.95.120
matt aluminum	111.95.121
matt nickel	111.95.122
black	111.95.313
matt gold	111.95.124
slate/graphite	111.95.125

Dimensions in mm unless otherwise noted.

# TAG MODERN

**Note**

Finishes match and are ideal for use with Synergy, Synergy Elite, Engage and Signature closet accessories. Supplied with 1" screws.  
 \* Indicates finish shown.

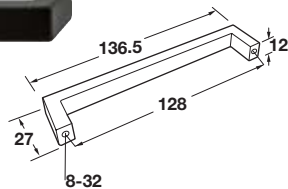

**Material**  
Zinc

Finish	Item No.
polished chrome	111.95.100
matt aluminum	111.95.101
matt nickel	111.95.102
black*	111.95.311
matt gold	111.95.104
slate/graphite	111.95.105

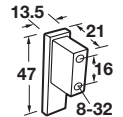

**Material**  
Zinc

Finish	Item No.
polished chrome	111.95.110
matt aluminum	111.95.111
matt nickel*	111.95.112
black	111.95.304
matt gold	111.95.114
slate/graphite	111.95.115

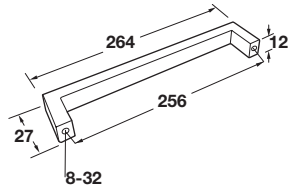

**Material**  
Zinc

Finish	Item No.
polished chrome	111.95.290
matt aluminum	111.95.291
matt nickel	111.95.292
black	111.95.312
matt gold*	111.95.294
slate/graphite	111.95.295

Dimensions in mm unless otherwise noted.

# TAG MINIMALIST

**Note**

Finishes match and are ideal for use with Synergy, Synergy Elite, Engage and Signature closet accessories. Supplied with 1" screws.  
 \* Indicates finish shown.

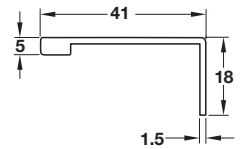

**Material**  
Aluminum

Finish	Length 3"	Length 9"	Length 18.5"	Length 24.5"	Length 30.5"	Length 36.5"
polished chrome	111.95.230	111.95.241	111.95.231	111.95.232	111.95.233	111.95.234
matt aluminum*	111.95.190	111.95.242	111.95.195	111.95.200	111.95.205	111.95.210
black*	111.95.320	111.95.321	111.95.322	111.95.323	111.95.324	111.95.325
matt gold*	111.95.192	111.95.244	111.95.197	111.95.202	111.95.207	111.95.212
slate/graphite	111.95.220	111.95.240	111.95.221	111.95.222	111.95.223	111.95.224

Dimensions in mm unless otherwise noted.

# AMEROCK ST. VINCENT COLLECTION

**Note**  
Supplied with 1" screws.

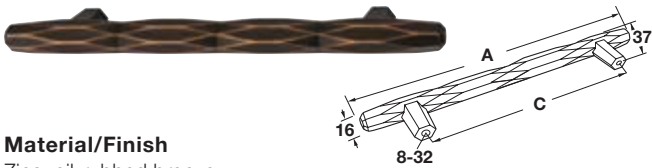

**Material/Finish**  
Zinc, oil-rubbed bronze

A	C	Item No.
160	96	133.50.387
191	128	133.50.385



**Material/Finish**  
Zinc, satin nickel

A	C	Item No.
160	96	133.50.393
191	128	133.50.391



**Material/Finish**  
Zinc, gold champagne

A	C	Item No.
160	96	133.50.384
191	128	133.50.382



**Material**  
Zinc

Finish	Item No.
oil-rubbed bronze	133.50.640

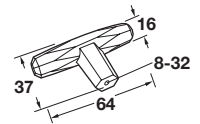

**Material**  
Zinc

Finish	Item No.
satin nickel	133.50.642



**Material**  
Zinc

Finish	Item No.
gold champagne	133.50.639

Dimensions in mm unless otherwise noted.

# AMEROCK REVITALIZE/ GRACE REVITALIZE COLLECTIONS

**Note**  
Supplied with 1" screws.



**Material/Finish**  
Zinc, oil-rubbed bronze

A	B	C	D	Item No.
94	35	76 (3")	14	133.50.359
110	37	96	16	133.50.360
143	40	128	17	133.50.357



**Material/Finish**  
Zinc, satin nickel

A	B	C	D	Item No.
94	35	76 (3")	14	133.50.363
110	37	96	16	133.50.364
143	40	128	17	133.50.361



**Material/Finish**  
Zinc, gold champagne

A	B	C	D	Item No.
94	35	76 (3")	14	133.50.368
110	37	96	16	133.50.369
143	40	128	17	133.50.365



**Material/Finish**  
Zinc, oil-rubbed bronze

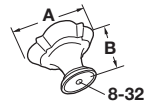

A	B	Item No.
35	30	133.50.325
44	35	133.50.326



**Material/Finish**  
Zinc, satin nickel

A	B	Item No.
35	30	133.50.329
44	35	133.50.330



**Material/Finish**  
Zinc, gold champagne

A	B	Item No.
35	30	133.50.323
44	35	133.50.324

Dimensions in mm unless otherwise noted.

# AMEROCK CUP PULLS

**Note**

Supplied with 1" screws.

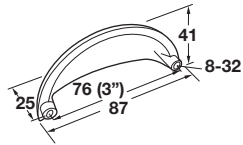

**Material**

Zinc

Finish	Item No.
oil-rubbed bronze	133.50.150



**Material**

Zinc

Finish	Item No.
polished chrome	133.50.134



**Material**

Zinc

Finish	Item No.
satin nickel	133.50.152



**Material**

Zinc

Finish	Item No.
gold champagne	133.50.147

Dimensions in mm unless otherwise noted.

# AMEROCK CRAWFORD COLLECTION

**Note**  
Supplied with 1" screws.



**Material/Finish**  
Zinc, oil-rubbed bronze

A	B	C	D	Item No.
119	35	96	19	133.50.258
154	37	128	21	133.50.256



**Material**  
Zinc

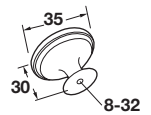

Finish	Item No.
oil-rubbed bronze	133.50.305



**Material/Finish**  
Zinc, satin nickel

A	B	C	D	Item No.
119	35	96	19	133.50.261
154	37	128	21	133.50.259



**Material**  
Zinc

Finish	Item No.
satin nickel	133.50.307



**Material/Finish**  
Zinc, gold champagne

A	B	C	D	Item No.
119	35	96	19	133.50.255
154	37	128	21	133.50.253



**Material**  
Zinc

Finish	Item No.
gold champagne	133.50.303

Dimensions in mm unless otherwise noted.

# AMEROCK SEA GRASS COLLECTION

**Note**  
Supplied with 1" screws.

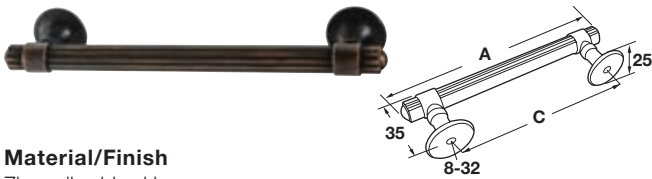

**Material/Finish**  
Zinc, oil-rubbed bronze

A	C	Item No.
127	96	133.50.378
159	128	133.50.376



**Material/Finish**  
Zinc, oil-rubbed bronze

A	B	C	Item No.
38	25	30	133.50.635
44	30	33	133.50.636



**Material/Finish**  
Zinc, satin nickel

A	C	Item No.
127	96	133.50.381
159	128	133.50.379



**Material/Finish**  
Zinc, satin nickel

A	B	C	Item No.
38	25	30	133.50.637
44	30	33	133.50.638



**Material/Finish**  
Zinc, gold champagne

A	C	Item No.
127	96	133.50.375
159	128	133.50.373



**Material/Finish**  
Zinc, gold champagne

A	B	C	Item No.
38	25	30	133.50.633
44	30	33	133.50.634

Dimensions in mm unless otherwise noted.



# AMEROCK CANDLER COLLECTION

**Note**  
Supplied with 1" screws.



**Material/Finish**  
Zinc, oil-rubbed bronze

A	B	C	D	Item No.
132	30	96	19	133.50.190
167	32	128	21	133.50.187



**Material/Finish**  
Zinc, oil-rubbed bronze

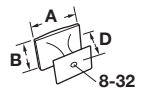

A	B	D	Item No.
32	25	29	133.50.239
38	32	32	133.50.240



**Material/Finish**  
Zinc, satin nickel

A	B	C	D	Item No.
132	30	96	19	133.50.198
167	32	128	21	133.50.195



**Material/Finish**  
Zinc, satin nickel

A	B	D	Item No.
32	25	29	133.50.243
38	32	32	133.50.244



**Material/Finish**  
Zinc, gold champagne

A	B	C	D	Item No.
132	30	96	19	133.53.087
167	32	128	21	133.53.088



**Material/Finish**  
Zinc, gold champagne

A	B	D	Item No.
32	25	29	133.53.085
38	32	32	133.53.091

Dimensions in mm unless otherwise noted.

# AMEROCK ESQUIRE COLLECTION

**Note**  
Supplied with 1" screws.



**Material/Finish**  
Zinc/Stainless Steel, polished nickel/black bronzed

A	C	Item No.
119	76 (3")/96	133.50.686
151	128	133.50.682



**Material**  
Zinc/Stainless Steel

Finish	Item No.
polished nickel/black bronzed	133.50.707



**Material/Finish**  
Zinc/Stainless Steel, polished nickel/gunmetal

A	C	Item No.
119	76 (3")/96	133.50.691
151	128	133.50.687



**Material**  
Zinc/Stainless Steel

Finish	Item No.
polished nickel/gunmetal	133.50.708



**Material/Finish**  
Zinc/Stainless Steel, polished nickel/stainless steel

A	C	Item No.
119	76 (3")/96	133.50.696
151	128	133.50.692



**Material**  
Zinc/Stainless Steel

Finish	Item No.
polished nickel/stainless steel	133.50.709



**Material/Finish**  
Zinc/Stainless Steel, satin nickel/oil-rubbed bronze

A	C	Item No.
119	76 (3")/96	133.50.702
151	128	133.50.697



**Material**  
Zinc/Stainless Steel

Finish	Item No.
satin nickel/oil-rubbed bronze	133.50.710

Dimensions in mm unless otherwise noted.

# AMEROCK BAR PULLS/GLACIO COLLECTIONS

**Note**

Supplied with 1" screws.

\* Indicates finishes shown in order.

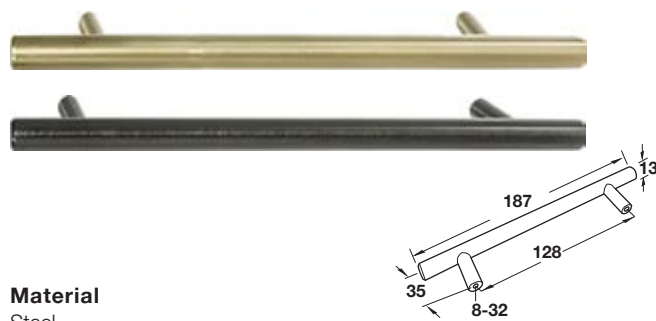
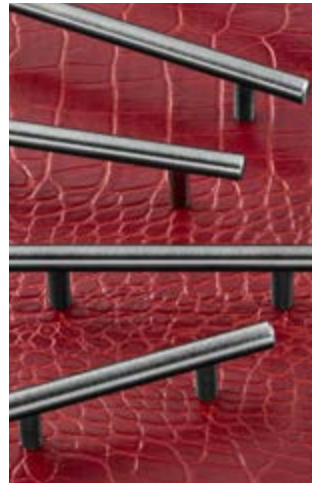

**Material**  
Steel

Finish	Item No.
gold champagne*	133.50.657
gunmetal*	133.50.664

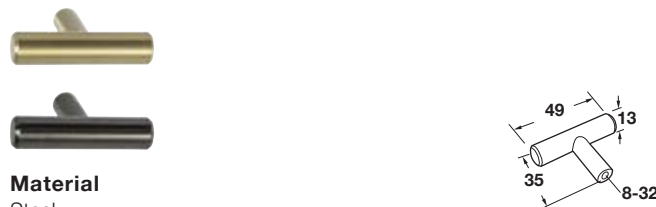

**Material**  
Steel

Finish	Item No.
gold champagne*	133.50.678
gunmetal*	133.50.679



**Material**

Aluminum/Synthetic Crystal

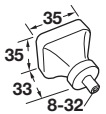

Finish	Item No.
gold champagne/clear*	133.50.111
oil-rubbed bronze/clear	133.50.117
satin nickel/clear	133.50.123



**Material**

Aluminum/Synthetic Crystal

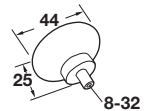

Finish	Item No.
gold champagne/clear	133.50.113
oil-rubbed bronze/clear	133.50.119
satin nickel/clear*	133.50.125



**Material**

Aluminum/Synthetic Crystal

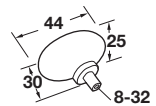

Finish	Item No.
gold champagne/clear	133.50.112
oil-rubbed bronze/clear*	133.50.118
satin nickel/clear	133.50.124

Dimensions in mm unless otherwise noted.

# DECORATIVE HOOKS

**Note**

\* Indicates finishes shown in order.

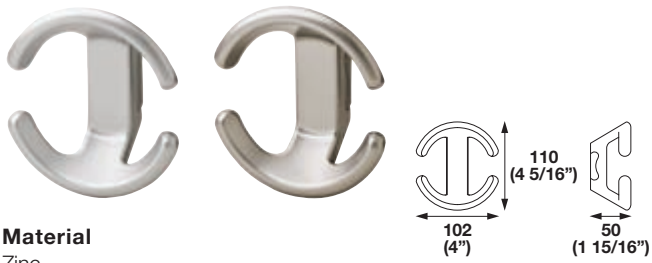

**Material**  
Zinc

Finish	Item No.
matt aluminum*	843.65.900
matt nickel*	843.65.600



**Material**  
Zinc

Finish	Item No.
satin nickel*	843.81.600
polished chrome*	843.81.200

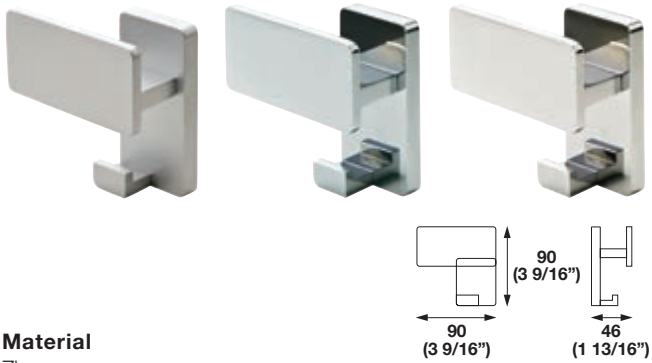

**Material**  
Zinc

Finish	Item No.
matt aluminum*	843.77.900
polished chrome*	843.77.200
satin nickel*	843.77.000

Dimensions in mm unless otherwise noted.

# DECORATIVE HOOKS

**Note**

\* Indicates finishes shown in order.



**Material**  
Zinc

Finish	Item No.
polished chrome*	844.69.240
satin nickel*	844.69.640

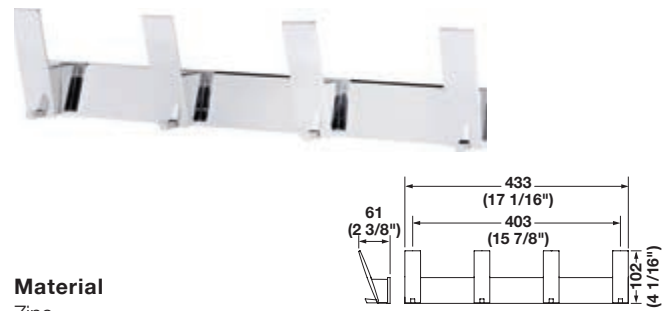

**Material**  
Zinc

Finish	Item No.
stainless steel look	844.69.630
polished chrome*	844.69.230



**Material**  
Zinc

Finish	Item No.
polished chrome	844.69.220

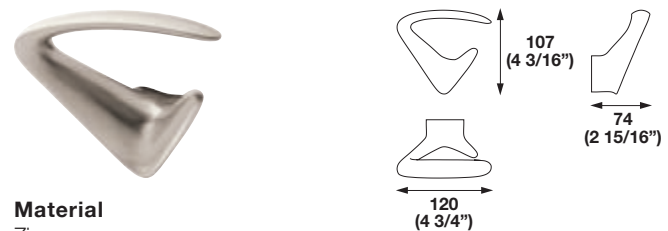

**Material**  
Zinc

Finish	Item No.
satin nickel	843.63.050

# HOOKS

**Note**

\* Indicates finish shown.



## HAT AND COAT HOOKS

> W x D x H: 1 1/2" x 3" x 3 5/8"

**Material**

Zinc



Finish	Item No.
polished chrome*	845.05.200
matt nickel	845.05.600
dark oil-rubbed bronze	845.05.300

**Supplied With**

Mounting screws

## HAT AND COAT HOOKS

> W x D x H: 1 1/16" x 2 3/16" x 3 9/16"

**Material**

Zinc



Finish	Item No.
polished chrome	885.06.209
matt nickel	845.01.600
dark oil-rubbed bronze*	845.01.300

**Supplied With**

Mounting screws

## HAT AND COAT HOOK

> W x D x H: 1 1/4" x 3 1/16" x 3 9/16"

**Material**

Zinc



Finish	Item No.
polished chrome	845.08.220
matt nickel*	845.08.620
dark oil-rubbed bronze	845.08.120

**Supplied With**

Mounting screws

## COAT HOOKS

**Material**

Aluminum, polished



W x D x H	Item No.
1 5/8" x 7/8" x 1 1/4"	845.10.805
2" x 1" x 1 9/16"	845.11.802
2 1/2" x 1 3/16" x 2"	845.12.809

## COAT HOOK

> W x D x H: 2 1/8" x 2 1/8" x 2 3/16"

**Material**

Aluminum, polished



Item No.
846.52.808

Dimensions in mm unless otherwise noted.

# HOOKS

**Note**

\* Indicates finish shown.



## COAT HOOKS



Material/Finish	W x D x H	Item No.
Aluminum, polished	3/4" x 1 1/8" x 1 1/2"	845.01.806
Aluminum, polished*	7/8" x 1 1/4" x 1 9/16"	845.02.803
Zinc, matt nickel	1 1/16" x 1 9/16" x 1 9/16"	845.01.620

## COAT HOOK

> W x D x H: 1/2" x 7/8" x 1 3/16"

**Material**  
Aluminum, polished



Item No.
845.00.809

## COAT HOOK

> W x D x H: 1 1/16" x 1 3/8" x 2 3/8"

**Material**  
Aluminum



Finish	Item No.
matt aluminum	842.01.909

## HAT AND COAT HOOK

> W x D x H: 1 1/16" x 3 11/16" x 6 1/4"

**Material**  
Aluminum



Finish	Item No.
matt aluminum	842.02.906

## HAT AND COAT HOOK

> W x D x H: 7/8" x 2 7/8" x 6"

**Material**  
Stainless Steel, matt



Item No.
842.34.000

**Supplied With** Screws

## HAT AND COAT HOOK

> W x D x H: 1" x 2" x 4 3/8"

**Material**  
Stainless Steel, matt



Item No.
842.34.010

**Supplied With** Screws

## HAT AND COAT HOOK

> W x D x H: 7/8" x 1 1/2" x 2 3/8"

**Material**  
Stainless Steel, matt



Item No.
842.34.050

**Supplied With** Screws

Dimensions in mm unless otherwise noted.

# PREMIUM ALUMINUM DOOR PROFILES

**Note**

\* Indicates finish shown.

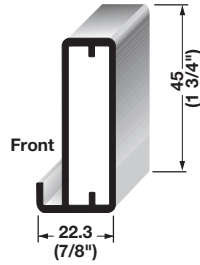

**Material**

Aluminum

Finish	Item No.
anodized, matt	563.56.931
brushed stainless steel*	563.56.031
white	563.56.731
bronze	563.56.131
black	563.56.331

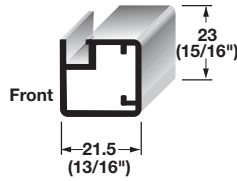

**Material**

Aluminum

Finish	Item No.
anodized, matt	563.55.931
brushed stainless steel*	563.55.031
polished aluminum	563.55.531
white	563.55.731
bronze	563.55.131
black	563.55.331

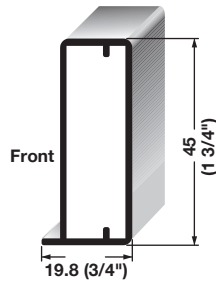

**Material**

Aluminum

Finish	Item No.
anodized, matt*	563.56.961
brushed stainless steel	563.56.061
white	563.56.761
bronze	563.56.161
black	563.56.361

# GLASS INFILL OPTIONS

Bronze Celsius Etch Mirrored

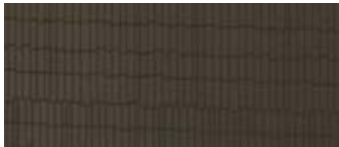

Clear Low Iron



Clear Ice White

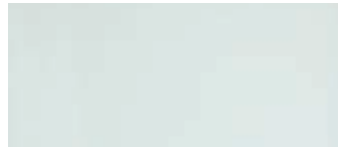

Bronze Tint



Pearl Etch



Soft Etch Low Iron



Soft Etch Mirrored



Structure Etch



Dimensions in mm unless otherwise noted.



# INDEX

<b>Item No.</b>	<b>Page No.</b>	<b>Item No.</b>	<b>Page No.</b>	<b>Item No.</b>	<b>Page No.</b>	<b>Item No.</b>	<b>Page No.</b>
100.45.051	149	111.95.160	152	111.95.291	153	133.50.147	157
100.45.055	149	111.95.161	152	111.95.292	153	133.50.150	157
102.47.953	148	111.95.162	152	111.95.294	153	133.50.152	157
103.79.401	143	111.95.164	152	111.95.295	153	133.50.187	160
103.79.411	143	111.95.165	152	111.95.300	150	133.50.190	160
104.08.000	148	111.95.170	150	111.95.301	152	133.50.195	160
104.35.600	141	111.95.171	150	111.95.302	150	133.50.198	160
107.18.352	141	111.95.172	150	111.95.303	152	133.50.239	160
107.18.353	141	111.95.174	150	111.95.304	153	133.50.240	160
107.18.358	141	111.95.175	150	111.95.305	151	133.50.243	160
107.18.612	141	111.95.180	150	111.95.306	151	133.50.244	160
107.18.613	141	111.95.181	150	111.95.307	151	133.50.253	158
107.18.618	141	111.95.182	150	111.95.308	150	133.50.255	158
109.50.274	143	111.95.184	150	111.95.309	150	133.50.256	158
110.18.057	140	111.95.185	150	111.95.310	150	133.50.258	158
110.18.357	140	111.95.190	154	111.95.311	153	133.50.259	158
111.25.252	143	111.95.192	154	111.95.312	153	133.50.261	158
111.25.262	143	111.95.195	154	111.95.313	152	133.50.303	158
111.95.000	152	111.95.197	154	111.95.320	154	133.50.305	158
111.95.001	152	111.95.200	154	111.95.321	154	133.50.307	158
111.95.003	152	111.95.202	154	111.95.322	154	133.50.323	156
111.95.004	152	111.95.205	154	111.95.323	154	133.50.324	156
111.95.005	152	111.95.207	154	111.95.324	154	133.50.325	156
111.95.063	147	111.95.210	154	111.95.325	154	133.50.326	156
111.95.069	147	111.95.212	154	117.05.600	146	133.50.329	156
111.95.100	153	111.95.220	154	117.05.610	146	133.50.330	156
111.95.101	153	111.95.221	154	117.05.620	146	133.50.357	156
111.95.102	153	111.95.222	154	117.05.640	146	133.50.359	156
111.95.104	153	111.95.223	154	117.97.351	144	133.50.360	156
111.95.105	153	111.95.224	154	117.97.352	144	133.50.361	156
111.95.110	153	111.95.230	154	117.97.357	144	133.50.363	156
111.95.111	153	111.95.231	154	117.97.358	144	133.50.364	156
111.95.112	153	111.95.232	154	117.97.359	144	133.50.365	156
111.95.114	153	111.95.233	154	124.02.220	149	133.50.368	156
111.95.115	153	111.95.234	154	124.02.320	149	133.50.369	156
111.95.120	152	111.95.240	154	124.02.332	149	133.50.373	159
111.95.121	152	111.95.241	154	124.02.432	149	133.50.375	159
111.95.122	152	111.95.242	154	124.02.501	149	133.50.376	159
111.95.124	152	111.95.244	154	124.02.920	149	133.50.378	159
111.95.125	152	111.95.260	151	124.02.921	149	133.50.379	159
111.95.130	150	111.95.261	151	125.68.051	140	133.50.381	159
111.95.131	150	111.95.262	151	125.68.052	140	133.50.382	155
111.95.132	150	111.95.263	151	125.68.351	140	133.50.384	155
111.95.134	150	111.95.265	151	125.68.352	140	133.50.385	155
111.95.135	150	111.95.270	151	131.33.700	146	133.50.387	155
111.95.140	150	111.95.271	151	133.50.111	162	133.50.391	155
111.95.141	150	111.95.272	151	133.50.112	162	133.50.393	155
111.95.142	150	111.95.273	151	133.50.113	162	133.50.633	159
111.95.144	150	111.95.275	151	133.50.117	162	133.50.634	159
111.95.145	150	111.95.280	151	133.50.118	162	133.50.635	159
111.95.150	150	111.95.281	151	133.50.119	162	133.50.636	159
111.95.151	150	111.95.282	151	133.50.123	162	133.50.637	159
111.95.152	150	111.95.283	151	133.50.124	162	133.50.638	159
111.95.154	150	111.95.285	151	133.50.125	162	133.50.639	155
111.95.155	150	111.95.290	153	133.50.134	157	133.50.640	155

## INDEX

Item No.	Page No.	Item No.	Page No.	Item No.	Page No.	Item No.	Page No.
133.50.642	155	155.00.789	146	155.99.025	147	372.27.350	133
133.50.657	162	155.00.795	146	155.99.026	147	372.27.351	133
133.50.664	162	155.00.801	145	155.99.027	147	372.27.352	133
133.50.678	162	155.00.810	146	155.99.028	147	372.27.353	133
133.50.679	162	155.00.811	146	155.99.029	147	372.27.354	133
133.50.682	161	155.00.840	147	155.99.030	147	372.27.500	133
133.50.686	161	155.00.841	147	155.99.031	147	372.27.501	133
133.50.687	161	155.00.870	147	155.99.032	147	372.27.502	133
133.50.691	161	155.00.871	147	231.07.401	64	372.27.503	133
133.50.692	161	155.01.610	142	231.07.410	64	372.27.504	133
133.50.696	161	155.01.611	142	237.56.350	63	372.27.600	133
133.50.697	161	155.01.612	142	237.56.352	63	372.27.602	133
133.50.702	161	155.01.613	142	237.56.380	63	372.27.700	133
133.50.707	161	155.01.620	142	237.56.381	63	372.27.701	133
133.50.708	161	155.01.621	142	237.56.974	63	372.27.702	133
133.50.709	161	155.01.622	142	237.56.988	63	372.27.703	133
133.50.710	161	155.01.623	142	237.56.992	63	372.27.704	133
133.53.085	160	155.01.668	145	237.56.994	63	422.72.381	123
133.53.087	160	155.01.669	145	237.56.995	63	422.72.392	123
133.53.088	160	155.01.818	147	237.56.996	63	422.73.300	123
133.53.091	160	155.01.819	147	237.56.997	63	422.73.790	123
133.79.051	140	155.02.410	145	237.56.998	63	422.73.792	123
133.79.351	140	155.02.411	145	237.56.999	63	422.74.310	122
134.06.311	147	155.02.412	145	271.92.016	73	422.74.320	122
134.06.441	147	155.02.413	144	271.92.025	73	422.74.900	123
134.06.641	147	155.02.414	144	271.92.132	73	424.31.300	123
135.73.400	143	155.02.415	144	271.92.200	75	424.31.310	123
135.73.410	143	155.02.420	145	271.92.201	75	424.31.900	123
138.72.800	143	155.02.421	145	271.92.202	75	424.31.910	123
139.60.422	143	155.02.430	147	271.92.250	75	429.59.340	120
155.00.040	142	155.99.000	145	271.92.260	75	429.59.350	120
155.00.041	142	155.99.001	145	271.92.261	75	429.59.370	120
155.00.060	142	155.99.002	145	271.92.262	75	429.59.371	120
155.00.061	142	155.99.003	145	271.92.265	75	429.59.372	120
155.00.071	142	155.99.004	145	271.92.266	75	429.97.222	129
155.00.072	142	155.99.005	144	271.92.267	75	429.97.231	129
155.00.091	142	155.99.006	144	271.92.268	75	429.97.240	129
155.00.092	142	155.99.007	144	271.92.269	75	429.97.526	129
155.00.440	148	155.99.008	144	271.92.270	75	429.99.020	129
155.00.441	148	155.99.009	144	271.92.271	75	429.99.039	129
155.00.491	148	155.99.010	144	271.92.272	75	429.99.048	129
155.00.492	148	155.99.011	144	271.92.273	75	429.99.128	129
155.00.600	148	155.99.012	144	271.92.274	75	429.99.137	129
155.00.601	148	155.99.013	144	271.92.275	75	429.99.146	129
155.00.696	145	155.99.014	144	271.92.290	76	429.99.324	129
155.00.697	145	155.99.015	144	271.98.100	73	429.99.333	129
155.00.721	145	155.99.016	144	283.38.020	138	429.99.342	129
155.00.751	145	155.99.017	144	283.39.010	137	429.99.422	129
155.00.764	144	155.99.018	147	283.39.011	137	429.99.431	129
155.00.765	144	155.99.019	147	283.39.019	137	429.99.440	129
155.00.766	145	155.99.020	147	283.39.021	136	429.99.520	129
155.00.780	146	155.99.021	147	283.39.022	137	429.99.539	129
155.00.781	146	155.99.022	147	283.39.030	136, 137	429.99.548	129
155.00.783	146	155.99.023	147	283.39.031	136	429.99.726	129
155.00.787	146	155.99.024	147	283.39.032	136, 137	429.99.735	129

# INDEX

<b>Item No.</b>	<b>Page No.</b>	<b>Item No.</b>	<b>Page No.</b>	<b>Item No.</b>	<b>Page No.</b>	<b>Item No.</b>	<b>Page No.</b>
429.99.744	129	547.36.487	54	547.40.238	53	547.41.632	53
502.72.701	106	547.36.488	54	547.40.252	53	547.41.636	53
502.72.705	106	547.36.489	54	547.40.256	53	547.41.638	53
502.72.722	106	547.37.484	54	547.40.258	53	547.41.652	53
502.72.990	106	547.37.485	54	547.40.332	53	547.41.656	53
502.72.993	106	547.37.486	54	547.40.336	53	547.41.658	53
503.15.365	105	547.37.487	54	547.40.338	53	547.41.732	53
503.15.765	105	547.37.488	54	547.40.352	53	547.41.736	53
503.15.865	105	547.37.489	54	547.40.356	53	547.41.738	53
505.03.232	112	547.38.212	53	547.40.358	53	547.41.752	53
520.10.009	111	547.38.216	53	547.40.532	53	547.41.756	53
520.20.280	62	547.38.218	53	547.40.536	53	547.41.758	53
520.44.500	111	547.38.232	53	547.40.538	53	547.41.812	53
520.44.700	111	547.38.236	53	547.40.632	53	547.41.816	53
521.99.140	110	547.38.238	53	547.40.636	53	547.41.818	53
521.99.141	110	547.38.252	53	547.40.638	53	547.41.832	53
521.99.300	109	547.38.256	53	547.40.652	53	547.41.836	53
521.99.310	109	547.38.258	53	547.40.656	53	547.41.838	53
521.99.320	109	547.38.332	53	547.40.658	53	547.41.852	53
521.99.331	109	547.38.336	53	547.40.712	53	547.41.856	53
521.99.332	109	547.38.338	53	547.40.716	53	547.41.858	53
521.99.333	109	547.38.352	53	547.40.718	53	547.42.231	55
521.99.340	110	547.38.356	53	547.40.732	53	547.42.232	55
521.99.341	110	547.38.358	53	547.40.736	53	547.42.241	55
521.99.800	109	547.38.532	53	547.40.738	53	547.42.242	55
521.99.810	109	547.38.536	53	547.40.752	53	547.42.331	55
521.99.820	109	547.38.538	53	547.40.756	53	547.42.332	55
521.99.831	109	547.38.632	53	547.40.758	53	547.42.341	55
521.99.832	109	547.38.636	53	547.40.812	53	547.42.342	55
521.99.833	109	547.38.638	53	547.40.816	53	547.42.390	55
521.99.900	109	547.38.652	53	547.40.818	53	547.42.485	56
521.99.910	109	547.38.656	53	547.40.832	53	547.42.486	56
521.99.920	109	547.38.658	53	547.40.836	53	547.42.487	56
521.99.931	109	547.38.716	53	547.40.838	53	547.42.488	56
521.99.932	109	547.38.718	53	547.40.852	53	547.42.531	55
521.99.933	109	547.38.732	53	547.40.856	53	547.42.532	55
540.06.996	57	547.38.736	53	547.40.858	53	547.42.590	55
540.09.755	57	547.38.738	53	547.41.212	53	547.42.631	55
540.36.207	113	547.38.752	53	547.41.216	53	547.42.632	55
540.42.200	113	547.38.756	53	547.41.218	53	547.42.641	55
540.50.114	108	547.38.758	53	547.41.232	53	547.42.642	55
540.50.117	108	547.38.812	53	547.41.236	53	547.42.690	55
540.50.204	108	547.38.816	53	547.41.238	53	547.42.731	55
540.50.207	108	547.38.818	53	547.41.252	53	547.42.732	55
543.19.260	113	547.38.832	53	547.41.256	53	547.42.741	55
543.19.280	113	547.38.836	53	547.41.258	53	547.42.742	55
547.35.484	54	547.38.838	53	547.41.332	53	547.42.831	55
547.35.485	54	547.38.852	53	547.41.336	53	547.42.832	55
547.35.486	54	547.38.856	53	547.41.338	53	547.42.841	55
547.35.487	54	547.38.858	53	547.41.352	53	547.42.842	55
547.35.488	54	547.40.212	53	547.41.356	53	547.42.890	55
547.35.489	54	547.40.216	53	547.41.358	53	547.42.990	55
547.36.484	54	547.40.218	53	547.41.532	53	547.42.991	55
547.36.485	54	547.40.232	53	547.41.536	53	547.42.993	56
547.36.486	54	547.40.236	53	547.41.538	53	547.42.994	56

## INDEX

<b>Item No.</b>	<b>Page No.</b>	<b>Item No.</b>	<b>Page No.</b>	<b>Item No.</b>	<b>Page No.</b>	<b>Item No.</b>	<b>Page No.</b>
547.43.311	46	547.52.526	38	563.56.931	167	635.61.376	131
547.43.313	46	547.52.540	38	563.56.961	167	635.61.378	131
547.43.315	46	547.52.580	38	568.60.581	61	635.61.395	131
547.43.390	46	547.52.590	38	568.60.710	61	635.61.397	131
547.43.391	46	547.52.599	38	568.60.781	61	635.61.476	131
547.43.399	46	547.52.621	38	568.66.700	61	635.61.496	131
547.51.201	57	547.52.622	38	568.66.790	61	635.61.977	131
547.51.202	57	547.52.623	38	568.67.900	62	635.61.996	131
547.51.203	57	547.52.624	38	568.67.990	62	771.80.430	60
547.51.204	57	547.52.626	38	630.46.382	132	771.80.431	60
547.51.206	57	547.52.640	38	630.46.390	132	771.80.435	60
547.51.218	113	547.52.680	38	630.46.391	132	771.80.436	60
547.51.227	113	547.52.690	38	630.46.392	132	774.10.621	135
547.51.236	113	547.52.699	38	630.46.393	132	774.10.623	135
547.51.245	113	547.52.921	38	630.46.394	132	774.10.625	135
547.51.254	113	547.52.922	38	630.46.395	132	774.10.626	135
547.51.263	113	547.52.923	38	631.03.340	130	774.10.628	135
547.51.301	57	547.52.924	38	631.03.341	130	774.10.630	135
547.51.302	57	547.52.926	38	631.03.740	130	774.10.632	135
547.51.303	57	547.52.940	38	631.03.741	130	774.10.640	135
547.51.304	57	547.52.980	38	631.20.310	129	774.10.642	135
547.51.306	57	547.52.990	38	631.20.710	129	774.10.644	135
547.51.601	57	547.52.999	38	631.20.910	129	774.10.645	135
547.51.602	57	547.94.385	60	631.26.111	129	774.10.647	135
547.51.603	57	547.94.485	60	631.26.112	129	774.10.649	135
547.51.604	57	547.95.431	56	631.26.311	129	774.10.651	135
547.51.606	57	547.95.432	56	631.26.411	129	774.11.622	135
547.52.040	38	547.95.433	56	631.26.412	129	774.11.624	135
547.52.221	38	547.95.434	56	631.26.511	129	774.11.626	135
547.52.222	38	547.98.441	54	631.26.512	129	774.11.629	135
547.52.223	38	547.98.443	54	631.26.611	129	774.11.630	135
547.52.224	38	547.98.445	54	631.26.711	129	774.11.631	135
547.52.226	38	547.98.452	54	631.35.014	129	774.11.633	135
547.52.240	38	547.98.454	54	631.35.214	129	774.11.634	135
547.52.280	38	547.98.456	54	631.35.314	129	774.11.635	135
547.52.290	38	547.98.461	54	631.39.310	130	774.11.645	135
547.52.299	38	547.98.463	54	631.39.320	130	774.11.647	135
547.52.321	38	547.98.465	54	631.39.720	130	774.11.649	135
547.52.322	38	547.98.472	54	632.52.300	119	774.11.652	135
547.52.323	38	547.98.474	54	633.44.000	122	774.11.656	135
547.52.324	38	547.98.476	54	633.55.090	119	792.00.000	81, 83
547.52.326	38	563.55.031	167	634.46.030	131	792.00.001	81
547.52.340	38	563.55.131	167	634.46.031	131	792.00.002	81
547.52.380	38	563.55.331	167	634.46.032	131	792.00.310	81
547.52.390	38	563.55.531	167	634.46.035	131	792.00.320	81, 83
547.52.399	38	563.55.731	167	634.46.036	131	792.01.000	83
547.52.421	38	563.55.931	167	634.46.037	131	792.01.030	83
547.52.422	38	563.56.031	167	634.46.040	131	792.01.045	89
547.52.423	38	563.56.061	167	634.46.041	131	792.01.060	149
547.52.424	38	563.56.131	167	634.46.042	131	792.01.080	87
547.52.426	38	563.56.161	167	634.46.090	131	792.01.081	87
547.52.521	38	563.56.331	167	635.48.060	87	792.01.082	87
547.52.522	38	563.56.361	167	635.48.061	87	792.01.083	87
547.52.523	38	563.56.731	167	635.61.276	131	792.01.380	87
547.52.524	38	563.56.761	167	635.61.295	131	792.01.381	87

# INDEX

<b>Item No.</b>	<b>Page No.</b>	<b>Item No.</b>	<b>Page No.</b>	<b>Item No.</b>	<b>Page No.</b>	<b>Item No.</b>	<b>Page No.</b>
792.01.382	87	792.10.642	93	792.13.010	91, 96	792.16.701	92
792.01.993	81	792.10.662	93	792.13.020	96	792.16.710	92
792.01.998	81	792.10.682	93	792.13.030	90, 91, 97	792.16.711	92
792.02.000	82	792.10.721	92	792.13.040	91, 97	792.16.730	92
792.02.004	82, 85	792.10.731	92	792.13.060	91, 100	792.16.760	92
792.02.005	82, 84	792.10.742	93	792.13.070	99	792.16.770	92
792.02.006	85	792.10.752	93	792.13.080	100	792.16.900	92
792.02.007	87	792.10.762	93	792.13.090	91, 100	792.16.901	92
792.02.060	85	792.10.772	93	792.14.000	100	792.16.960	92
792.02.070	84	792.10.782	93	792.14.010	91, 99	792.22.060	102
792.02.099	88	792.10.792	93	792.14.020	100	792.22.160	102
792.02.200	82, 84	792.10.821	92	792.14.030	91, 100	792.22.300	90, 91, 97
792.02.201	82, 85	792.10.842	93	792.14.050	90, 103	792.22.310	99
792.02.202	82, 84	792.10.862	93	792.14.051	90, 103	792.22.320	99
792.02.203	82, 84	792.10.882	93	792.14.060	90, 101	792.22.340	98
792.02.240	82	792.10.931	92	792.14.070	90, 101	792.22.360	102
792.02.241	82	792.10.952	93	792.14.071	101	792.22.430	97
792.02.250	82, 86	792.10.972	93	792.14.080	90, 101	792.22.431	97
792.02.251	82, 86	792.10.992	93	792.14.090	101	792.22.450	102
792.02.252	82, 86	792.11.002	93	792.14.540	103	792.22.451	102
792.02.253	82, 86	792.11.050	94	792.14.640	103	792.22.460	102
792.02.254	82, 86	792.11.102	93	792.15.031	90	792.22.560	102
792.02.255	82, 86	792.11.150	94	792.15.041	90	792.22.660	102
792.02.349	82, 84, 85	792.11.302	93	792.15.051	91	792.22.760	102
792.02.380	82, 87	792.11.350	94	792.15.060	91	792.22.860	102
792.02.381	82, 87	792.11.412	93	792.15.071	90	792.22.960	102
792.02.382	82, 87	792.11.460	94	792.15.081	91	792.30.000	79
792.02.399	82, 87	792.11.502	93	792.15.091	91	792.30.010	80
792.03.900	88	792.11.550	94	792.15.300	90, 101	793.00.001	67
792.03.910	88	792.11.602	93	792.16.000	92	793.00.002	67
792.03.920	88	792.11.650	94	792.16.001	92	793.00.003	68
792.03.930	88	792.11.702	93	792.16.060	92	793.00.004	68
792.03.940	88	792.11.712	93	792.16.100	92	793.00.005	68
792.03.950	88	792.11.750	94	792.16.101	92	793.00.113	67
792.10.021	92	792.11.760	94	792.16.130	92	793.00.114	67
792.10.042	93	792.11.802	93	792.16.160	92	793.00.125	70
792.10.062	93	792.11.850	94	792.16.300	92	793.00.127	70
792.10.082	93	792.11.912	93	792.16.301	92	793.00.129	68
792.10.121	92	792.11.950	94	792.16.380	92	793.00.130	68
792.10.142	93	792.12.000	98	792.16.400	92	793.00.400	69
792.10.162	93	792.12.010	90, 91, 98	792.16.401	92	793.00.401	69
792.10.182	93	792.12.020	90, 91, 98	792.16.410	92	793.00.402	70
792.10.321	92	792.12.030	90, 91, 98	792.16.411	92	793.00.403	69
792.10.342	93	792.12.040	91, 98	792.16.460	92	793.00.404	69
792.10.362	93	792.12.050	90, 91, 95	792.16.470	92	793.00.405	70
792.10.382	93	792.12.051	90, 91, 95	792.16.480	92	793.00.412	69
792.10.431	92	792.12.060	90, 91, 95	792.16.500	92	793.00.413	69
792.10.452	93	792.12.061	90, 91, 96	792.16.501	92	793.00.414	70
792.10.472	93	792.12.070	90, 91, 95	792.16.530	92	793.00.415	69
792.10.492	93	792.12.071	90, 91, 95	792.16.560	92	793.00.416	69
792.10.521	92	792.12.072	90, 91, 95	792.16.600	92	793.00.417	70
792.10.542	93	792.12.073	90, 91, 95	792.16.601	92	793.00.424	69
792.10.562	93	792.12.080	90, 91, 96	792.16.630	92	793.00.425	69
792.10.582	93	792.12.090	90, 91, 96	792.16.660	92	793.00.426	70
792.10.621	92	792.13.000	91, 96	792.16.700	92	793.00.427	69

## INDEX

Item No.	Page No.	Item No.	Page No.	Item No.	Page No.	Item No.	Page No.
793.00.428	69	801.42.340	34	801.78.612	32	803.64.300	32
793.00.429	70	801.42.355	33	801.78.691	31	803.64.400	58
793.00.436	69	801.42.356	33	801.78.692	31	803.64.410	34
793.00.437	69	801.42.357	33	801.78.693	31	803.64.450	32
793.00.438	70	801.42.358	33	801.78.694	31	803.64.500	32
793.00.439	69	801.42.359	33	801.78.695	31	803.64.600	32
793.00.440	69	801.42.440	34	801.78.712	32	803.64.650	32
793.00.441	70	801.42.465	33	801.78.715	31	803.64.900	32
793.00.448	70	801.42.466	33	801.78.716	31	805.01.752	107
793.00.450	70	801.42.467	33	801.78.717	31	805.01.761	107
801.09.239	58	801.42.468	33	801.78.718	31	805.12.303	107
801.13.201	58	801.42.469	33	801.78.719	31	805.12.358	107
801.13.209	58	801.42.600	42	801.78.912	32	805.12.401	107
801.13.244	58	801.42.634	42	801.78.991	31	805.12.456	107
801.13.245	58	801.42.635	42	801.78.992	31	805.31.201	51
801.13.246	58	801.42.636	42	801.78.993	31	805.31.202	51
801.13.247	58	801.42.637	42	801.78.994	31	805.31.203	51
801.13.248	58	801.42.638	42	801.78.995	31	805.31.223	51
801.13.309	58	801.42.640	34	801.81.400	34	805.31.295	51
801.13.365	58	801.42.655	33	801.81.500	34	805.31.296	51
801.13.366	58	801.42.656	33	801.81.700	34	805.31.297	51
801.13.367	58	801.42.657	33	802.04.208	58	805.31.301	51
801.13.368	58	801.42.658	33	802.04.308	58	805.31.302	51
801.13.369	58	801.42.659	33	802.06.067	34	805.31.303	51
801.13.381	58	801.42.710	42	802.06.267	34, 42	805.31.323	51
801.13.384	58	801.42.900	42	802.06.367	34, 42	805.31.701	51
801.13.385	58	801.42.934	42	802.06.467	34	805.31.702	51
801.13.386	58	801.42.935	42	802.06.667	34, 42	805.31.703	51
801.13.387	58	801.42.936	42	802.06.767	34, 42	805.31.723	51
801.13.388	58	801.42.937	42	802.13.000	32	805.31.795	51
801.13.391	58	801.42.938	42	802.13.200	32	805.31.796	51
801.13.684	58	801.43.340	34	802.13.300	32	805.31.797	51
801.13.685	58	801.43.345	33	802.13.500	32	805.32.246	52
801.13.686	58	801.43.346	33	802.13.600	32	805.32.251	52
801.13.687	58	801.43.347	33	802.13.900	32	805.32.254	52
801.13.688	58	801.43.348	33	803.33.210	58	805.32.261	52
801.13.691	58	801.43.349	33	803.33.722	58	805.32.262	52
801.42.040	34	801.78.212	32	803.39.210	34	805.32.351	52
801.42.055	33	801.78.291	31	803.39.250	32	805.32.354	52
801.42.056	33	801.78.292	31	803.39.300	58	805.32.358	52
801.42.057	33	801.78.293	31	803.39.410	34	805.32.362	52
801.42.058	33	801.78.294	31	803.39.450	32	805.32.461	52
801.42.059	33	801.78.295	31	803.39.600	58	805.32.661	52
801.42.200	42	801.78.312	32	803.39.610	34	805.32.761	52
801.42.234	42	801.78.391	31	803.39.710	34	805.32.763	52
801.42.235	42	801.78.392	31	803.39.750	32	805.32.764	52
801.42.236	42	801.78.393	31	803.39.910	34	805.32.766	52
801.42.237	42	801.78.394	31	803.39.950	32	805.40.209	107
801.42.238	42	801.78.395	31	803.56.200	42	805.43.250	107
801.42.240	34	801.78.412	32	803.56.300	42	805.58.231	45
801.42.255	33	801.78.491	31	803.56.600	42	805.58.233	45
801.42.256	33	801.78.492	31	803.56.710	42	805.58.235	45
801.42.257	33	801.78.493	31	803.56.900	42	805.58.331	30, 45
801.42.258	33	801.78.494	31	803.64.000	32	805.58.332	30, 45
801.42.259	33	801.78.495	31	803.64.200	32	805.58.431	45

# INDEX

<b>Item No.</b>	<b>Page No.</b>	<b>Item No.</b>	<b>Page No.</b>	<b>Item No.</b>	<b>Page No.</b>	<b>Item No.</b>	<b>Page No.</b>
805.58.433	45	807.54.632	43	807.67.585	36	807.69.640	41
805.58.435	45	807.54.633	43	807.67.601	35	807.69.650	41
805.58.631	45	807.54.634	44	807.67.603	35	807.69.660	40
805.58.633	45	807.54.770	43	807.67.605	35	807.69.901	40
805.58.635	45	807.54.771	43	807.67.611	35	807.69.920	40
805.58.931	45	807.54.772	43	807.67.613	35	807.69.930	41
805.58.933	45	807.54.773	43	807.67.615	35	807.69.931	41
805.58.935	45	807.54.930	43	807.67.621	36	807.69.940	41
805.72.030	39	807.54.931	43	807.67.623	36	807.69.950	41
805.72.330	39	807.54.932	43	807.67.625	36	807.69.960	40
805.72.430	39	807.54.933	43	807.67.683	36	807.71.300	115
805.72.630	39	807.54.934	44	807.67.685	36	807.71.301	115
805.72.930	39	807.67.201	35	807.67.901	35	807.71.302	115
805.73.011	39	807.67.203	35	807.67.904	35	807.71.303	115
805.73.021	39	807.67.205	35	807.67.905	35	807.71.310	20
805.73.022	39	807.67.211	35	807.67.911	35	807.71.311	20
805.73.311	39	807.67.213	35	807.67.913	35	807.71.312	20
805.73.321	39	807.67.215	35	807.67.915	35	807.71.313	20
805.73.322	39	807.67.221	36	807.67.921	36	807.71.320	21
805.73.411	39	807.67.223	36	807.67.923	36	807.71.321	21
805.73.421	39	807.67.225	36	807.67.925	36	807.71.322	21
805.73.422	39	807.67.283	36	807.67.983	36	807.71.323	21
805.73.611	39	807.67.285	36	807.67.985	36	807.71.330	21
805.73.621	39	807.67.301	35	807.68.300	40	807.71.331	21
805.73.622	39	807.67.303	35	807.68.320	40	807.71.332	21
805.73.911	39	807.67.305	35	807.68.330	41	807.71.333	21
805.73.921	39	807.67.311	35	807.68.331	41	807.71.400	115
805.73.922	39	807.67.313	35	807.68.340	41	807.71.401	115
805.87.210	45	807.67.315	35	807.68.350	41	807.71.402	115
805.87.910	45	807.67.321	36	807.68.360	40	807.71.403	115
805.87.993	45	807.67.323	36	807.69.000	40	807.71.410	115
807.52.231	46	807.67.325	36	807.69.020	40	807.71.411	115
807.52.233	46	807.67.383	36	807.69.030	41	807.71.412	115
807.52.235	46	807.67.385	36	807.69.031	41	807.71.413	115
807.52.331	46	807.67.401	35	807.69.040	41	807.71.420	115
807.52.333	46	807.67.403	35	807.69.050	41	807.71.421	115
807.52.335	46	807.67.405	35	807.69.060	40	807.71.422	115
807.52.631	46	807.67.411	35	807.69.200	40	807.71.423	115
807.52.633	46	807.67.413	35	807.69.220	40	807.71.430	115
807.52.635	46	807.67.415	35	807.69.230	41	807.71.431	115
807.52.931	46	807.67.421	36	807.69.231	41	807.71.432	115
807.52.933	46	807.67.423	36	807.69.240	41	807.71.433	115
807.52.935	46	807.67.425	36	807.69.250	41	807.71.500	115
807.54.230	43	807.67.483	36	807.69.260	40	807.71.501	115
807.54.231	43	807.67.485	36	807.69.320	40	807.71.502	115
807.54.232	43	807.67.501	35	807.69.330	41	807.71.503	115
807.54.233	43	807.67.503	35	807.69.331	41	807.71.510	115
807.54.234	44	807.67.505	35	807.69.340	41	807.71.511	115
807.54.330	43	807.67.511	35	807.69.350	41	807.71.512	115
807.54.331	43	807.67.513	35	807.69.360	40	807.71.513	115
807.54.332	43	807.67.515	35	807.69.370	40	807.71.520	115
807.54.333	43	807.67.521	36	807.69.600	40	807.71.521	115
807.54.334	44	807.67.523	36	807.69.620	40	807.71.522	115
807.54.630	43	807.67.525	36	807.69.630	41	807.71.523	115
807.54.631	43	807.67.583	36	807.69.631	41	807.71.530	115

## INDEX

<b>Item No.</b>	<b>Page No.</b>	<b>Item No.</b>	<b>Page No.</b>	<b>Item No.</b>	<b>Page No.</b>	<b>Item No.</b>	<b>Page No.</b>
807.71.531	115	807.72.250	22	807.73.352	21	807.73.860	21
807.71.532	115	807.72.260	22	807.73.360	21	807.73.861	21
807.71.533	115	807.72.330	22	807.73.361	21	807.73.862	21
807.71.600	115	807.72.350	22	807.73.362	21	807.73.870	21
807.71.601	115	807.72.360	22	807.73.370	21	807.73.871	21
807.71.602	115	807.72.630	22	807.73.371	21	807.73.872	21
807.71.603	115	807.72.650	22	807.73.372	21	807.73.880	21
807.71.610	20	807.72.660	22	807.73.380	21	807.73.881	21
807.71.611	20	807.72.830	22	807.73.381	21	807.73.882	21
807.71.612	20	807.72.850	22	807.73.382	21	807.74.000	21
807.71.613	20	807.72.860	22	807.73.600	20	807.74.001	21
807.71.620	21	807.73.000	20	807.73.601	20	807.74.002	21
807.71.621	21	807.73.001	20	807.73.602	20	807.74.010	21
807.71.622	21	807.73.002	20	807.73.610	20	807.74.011	21
807.71.623	21	807.73.010	20	807.73.611	20	807.74.012	21
807.71.630	21	807.73.011	20	807.73.612	20	807.74.020	21
807.71.631	21	807.73.012	20	807.73.620	20	807.74.021	21
807.71.632	21	807.73.020	20	807.73.621	20	807.74.022	21
807.71.633	21	807.73.021	20	807.73.622	20	807.74.300	21
807.71.700	115	807.73.022	20	807.73.630	20	807.74.301	21
807.71.701	115	807.73.030	20	807.73.631	20	807.74.302	21
807.71.702	115	807.73.031	20	807.73.632	20	807.74.310	21
807.71.703	115	807.73.032	20	807.73.640	21	807.74.311	21
807.71.710	115	807.73.040	21	807.73.641	21	807.74.312	21
807.71.711	115	807.73.041	21	807.73.642	21	807.74.320	21
807.71.712	115	807.73.042	21	807.73.650	21	807.74.321	21
807.71.713	115	807.73.050	21	807.73.651	21	807.74.322	21
807.71.720	115	807.73.051	21	807.73.652	21	807.74.600	21
807.71.721	115	807.73.052	21	807.73.660	21	807.74.601	21
807.71.722	115	807.73.060	21	807.73.661	21	807.74.602	21
807.71.723	115	807.73.061	21	807.73.662	21	807.74.610	21
807.71.730	115	807.73.062	21	807.73.670	21	807.74.611	21
807.71.731	115	807.73.070	21	807.73.671	21	807.74.612	21
807.71.732	115	807.73.071	21	807.73.672	21	807.74.620	21
807.71.733	115	807.73.072	21	807.73.680	21	807.74.621	21
807.71.800	115	807.73.080	21	807.73.681	21	807.74.622	21
807.71.801	115	807.73.081	21	807.73.682	21	807.74.800	21
807.71.802	115	807.73.082	21	807.73.800	20	807.74.801	21
807.71.803	115	807.73.300	20	807.73.801	20	807.74.802	21
807.71.810	20	807.73.301	20	807.73.802	20	807.74.810	21
807.71.811	20	807.73.302	20	807.73.810	20	807.74.811	21
807.71.812	20	807.73.310	20	807.73.811	20	807.74.812	21
807.71.813	20	807.73.311	20	807.73.812	20	807.74.820	21
807.71.820	21	807.73.312	20	807.73.820	20	807.74.821	21
807.71.821	21	807.73.320	20	807.73.821	20	807.74.822	21
807.71.822	21	807.73.321	20	807.73.822	20	807.76.300	47
807.71.823	21	807.73.322	20	807.73.830	20	807.76.301	47
807.71.830	21	807.73.330	20	807.73.831	20	807.76.302	47
807.71.831	21	807.73.331	20	807.73.832	20	807.76.303	47
807.71.832	21	807.73.332	20	807.73.840	21	807.76.310	47
807.71.833	21	807.73.340	21	807.73.841	21	807.76.311	47
807.72.030	22	807.73.341	21	807.73.842	21	807.76.312	47
807.72.050	22	807.73.342	21	807.73.850	21	807.76.313	47
807.72.060	22	807.73.350	21	807.73.851	21	807.76.320	47
807.72.230	22	807.73.351	21	807.73.852	21	807.76.321	47



# INDEX

<b>Item No.</b>	<b>Page No.</b>	<b>Item No.</b>	<b>Page No.</b>	<b>Item No.</b>	<b>Page No.</b>	<b>Item No.</b>	<b>Page No.</b>
807.76.322	47	807.77.012	26	807.77.622	27	807.78.322	27
807.76.323	47	807.77.013	26	807.77.623	27	807.78.323	27
807.76.330	47	807.77.014	26	807.77.624	27	807.78.324	27
807.76.331	47	807.77.021	27	807.77.671	28	807.78.581	25
807.76.332	47	807.77.022	27	807.77.672	28	807.78.582	25
807.76.333	47	807.77.023	27	807.77.673	28	807.78.583	25
807.76.390	47	807.77.024	27	807.77.674	28	807.78.584	25
807.76.391	47	807.77.071	28	807.77.681	25	807.78.599	24
807.76.392	47	807.77.072	28	807.77.682	25	807.81.000	30
807.76.393	47	807.77.073	28	807.77.683	25	807.81.001	30
807.76.600	47	807.77.074	28	807.77.684	25	807.81.002	30
807.76.601	47	807.77.081	25	807.77.699	24	807.81.003	30
807.76.602	47	807.77.082	25	807.77.796	24	807.81.200	30
807.76.603	47	807.77.083	25	807.77.901	24	807.81.201	30
807.76.610	47	807.77.084	25	807.77.902	24	807.81.202	30
807.76.611	47	807.77.199	24	807.77.903	24	807.81.203	30
807.76.612	47	807.77.271	28	807.77.904	24	807.81.410	29
807.76.613	47	807.77.272	28	807.77.911	26	807.81.411	29
807.76.620	47	807.77.273	28	807.77.912	26	807.81.412	29
807.76.621	47	807.77.274	28	807.77.913	26	807.81.413	29
807.76.622	47	807.77.281	25	807.77.914	26	807.81.510	29
807.76.623	47	807.77.282	25	807.77.921	27	807.81.511	29
807.76.630	47	807.77.283	25	807.77.922	27	807.81.512	29
807.76.631	47	807.77.284	25	807.77.923	27	807.81.513	29
807.76.632	47	807.77.299	24	807.77.924	27	807.81.600	30
807.76.633	47	807.77.340	29	807.77.971	28	807.81.601	30
807.76.690	47	807.77.341	29	807.77.972	28	807.81.602	30
807.76.691	47	807.77.342	29	807.77.973	28	807.81.603	30
807.76.692	47	807.77.360	28	807.77.974	28	807.81.710	29
807.76.693	47	807.77.361	28	807.77.981	25	807.81.711	29
807.76.800	47	807.77.362	28	807.77.982	25	807.81.712	29
807.76.801	47	807.77.391	26	807.77.983	25	807.81.713	29
807.76.802	47	807.77.392	27	807.77.984	25	807.81.900	30
807.76.803	47	807.77.440	29	807.77.999	24	807.81.901	30
807.76.810	47	807.77.441	29	807.78.101	24	807.81.902	30
807.76.811	47	807.77.442	29	807.78.102	24	807.81.903	30
807.76.812	47	807.77.460	28	807.78.103	24	807.81.920	29
807.76.813	47	807.77.461	28	807.78.104	24	807.81.921	29
807.76.820	47	807.77.462	28	807.78.111	26	807.81.922	29
807.76.821	47	807.77.491	26	807.78.112	26	807.81.923	29
807.76.822	47	807.77.492	27	807.78.113	26	807.82.320	29
807.76.823	47	807.77.571	28	807.78.114	26	807.82.321	29
807.76.830	47	807.77.572	28	807.78.121	27	807.82.322	29
807.76.831	47	807.77.573	28	807.78.122	27	807.82.323	29
807.76.832	47	807.77.574	28	807.78.123	27	807.82.500	30
807.76.833	47	807.77.596	24	807.78.124	27	807.82.501	30
807.76.890	47	807.77.601	24	807.78.301	24	807.82.502	30
807.76.891	47	807.77.602	24	807.78.302	24	807.82.503	30
807.76.892	47	807.77.603	24	807.78.303	24	808.70.230	44
807.76.893	47	807.77.604	24	807.78.304	24	808.70.231	44
807.77.001	24	807.77.611	26	807.78.311	26	808.70.330	44
807.77.002	24	807.77.612	26	807.78.312	26	808.70.331	44
807.77.003	24	807.77.613	26	807.78.313	26	808.70.630	44
807.77.004	24	807.77.614	26	807.78.314	26	808.70.631	44
807.77.011	26	807.77.621	27	807.78.321	27	808.70.770	44

## INDEX

Item No.	Page No.	Item No.	Page No.	Item No.	Page No.	Item No.	Page No.
808.70.771	44	822.09.304	127	833.96.035	48	845.00.809	166
808.70.930	44	822.09.305	127	833.96.036	48	845.01.300	165
808.70.931	44	822.09.306	127	833.96.037	48	845.01.600	165
808.71.001	37	822.09.307	127	833.96.038	48	845.01.620	166
808.71.003	37	822.09.308	127	833.96.039	48	845.01.806	166
808.71.201	37	822.09.330	124	833.96.040	48	845.02.803	166
808.71.203	37	822.09.331	124	833.96.041	48	845.05.200	165
808.71.301	37	822.09.930	124	833.96.042	48	845.05.300	165
808.71.303	37	822.09.931	124	833.96.043	48	845.05.600	165
808.71.401	37	822.53.359	128	833.96.044	48	845.08.120	165
808.71.403	37	822.53.360	128	833.96.045	48	845.08.220	165
808.71.501	37	822.53.361	128	833.96.046	48	845.08.620	165
808.71.503	37	822.53.362	128	833.96.047	48	845.10.805	165
808.71.601	37	822.53.363	128	833.96.048	48	845.11.802	165
808.71.603	37	822.53.364	128	833.96.049	48	845.12.809	165
808.72.000	37	822.53.365	128	833.96.050	48	846.52.808	165
808.72.200	37	822.53.366	128	833.96.051	48	885.06.209	165
808.72.300	37	822.53.367	128	833.96.052	48	888.00.015	111
808.72.400	37	822.53.371	128	833.96.053	48	888.00.024	111
808.72.600	37	822.53.372	128	833.96.054	48		
808.72.900	37	822.53.373	128	833.96.055	48		
811.03.000	59	822.64.033	124	833.96.056	48		
811.03.110	59	822.99.320	125	833.96.057	48		
811.03.120	59	822.99.330	127	833.96.058	48		
811.03.301	59	822.99.340	125	833.96.059	48		
811.03.320	59	822.99.350	124	833.96.060	48		
811.03.380	59	822.99.355	126	833.96.061	48		
811.03.504	59	822.99.356	126	833.96.062	48		
811.03.513	59	822.99.357	126	833.96.063	48		
811.03.520	59	822.99.358	126	833.96.064	48		
811.03.530	59	830.28.715	42	833.96.065	48		
811.03.800	59	830.28.830	42	833.96.066	48		
811.03.980	59	830.28.831	42	833.96.067	48		
811.05.000	60	830.28.832	42	836.21.351	65		
811.05.110	60	830.28.833	42	836.50.300	66		
811.05.500	60	830.28.834	42	836.50.310	66		
811.05.800	60	833.72.880	64	836.50.311	66		
818.45.300	121	833.72.881	64	842.01.909	166		
818.45.310	121	833.72.882	64	842.02.906	166		
818.45.900	121	833.95.002	48	842.34.000	166		
818.45.910	121	833.96.020	48	842.34.010	166		
818.83.900	89	833.96.021	48	842.34.050	166		
818.83.910	89	833.96.022	48	843.63.050	164		
818.83.920	89	833.96.023	48	843.65.600	163		
818.83.930	89	833.96.024	48	843.65.900	163		
818.83.940	89	833.96.025	48	843.77.000	163		
818.84.000	116	833.96.026	48	843.77.200	163		
818.84.200	116	833.96.027	48	843.77.900	163		
818.84.300	116	833.96.028	48	843.81.200	163		
818.84.600	116	833.96.029	48	843.81.600	163		
818.84.710	118	833.96.030	48	844.69.220	164		
818.84.720	118	833.96.031	48	844.69.230	164		
818.84.730	117	833.96.032	48	844.69.240	164		
818.84.740	117	833.96.033	48	844.69.630	164		
818.84.800	116	833.96.034	48	844.69.640	164		

# EASIER TO ACCESS. EASIER TO USE.



WE KNOW YOU'RE ALWAYS ON THE GO AND MAY NOT ALWAYS BE USING A DESKTOP OR LAPTOP TO ACCESS OUR WEBSITE. AND THAT'S EXACTLY WHY OUR SITE HAS BEEN UPDATED WITH YOU IN MIND.

- Improved user experience on any device
- More robust, intuitive navigation
- Updated category displays include more information
- Login and shop on mobile, tablet, desktop or all three!

## STANDARD TERMS AND CONDITIONS OF SALE

All purchases from Häfele America Co. are subject to the Terms and Conditions in effect at the time of shipment. Häfele's Terms and Conditions are set forth on its website, hafele.com, and are incorporated herein by reference. Should you not have access to the above web site and wish to obtain a printed copy of the Terms and Conditions, please contact your Häfele Sales Representative and a copy will be sent to you.

# HÄFELE

HAF-CLS-2022

**Häfele America Co.** | 3901 Cheyenne Drive | Archdale, NC 27263

**Phone:** 800 423 3531 | **Fax:** 800 325 6197 | **Showrooms:** New York, Archdale, Los Angeles

**[hafele.com](http://hafele.com)**

© & TM Häfele GmbH & Co KG and/or Häfele America Co. Other trademarks referenced are owned by their respective owners. All rights reserved. Materials, designs and design elements shown herein may be the subject of US and International copyright and other forms of legal protection.